

# Technics

## D.S.P. AV CONTROL STEREO RECEIVER

### SA-GX910

#### Operating Instructions

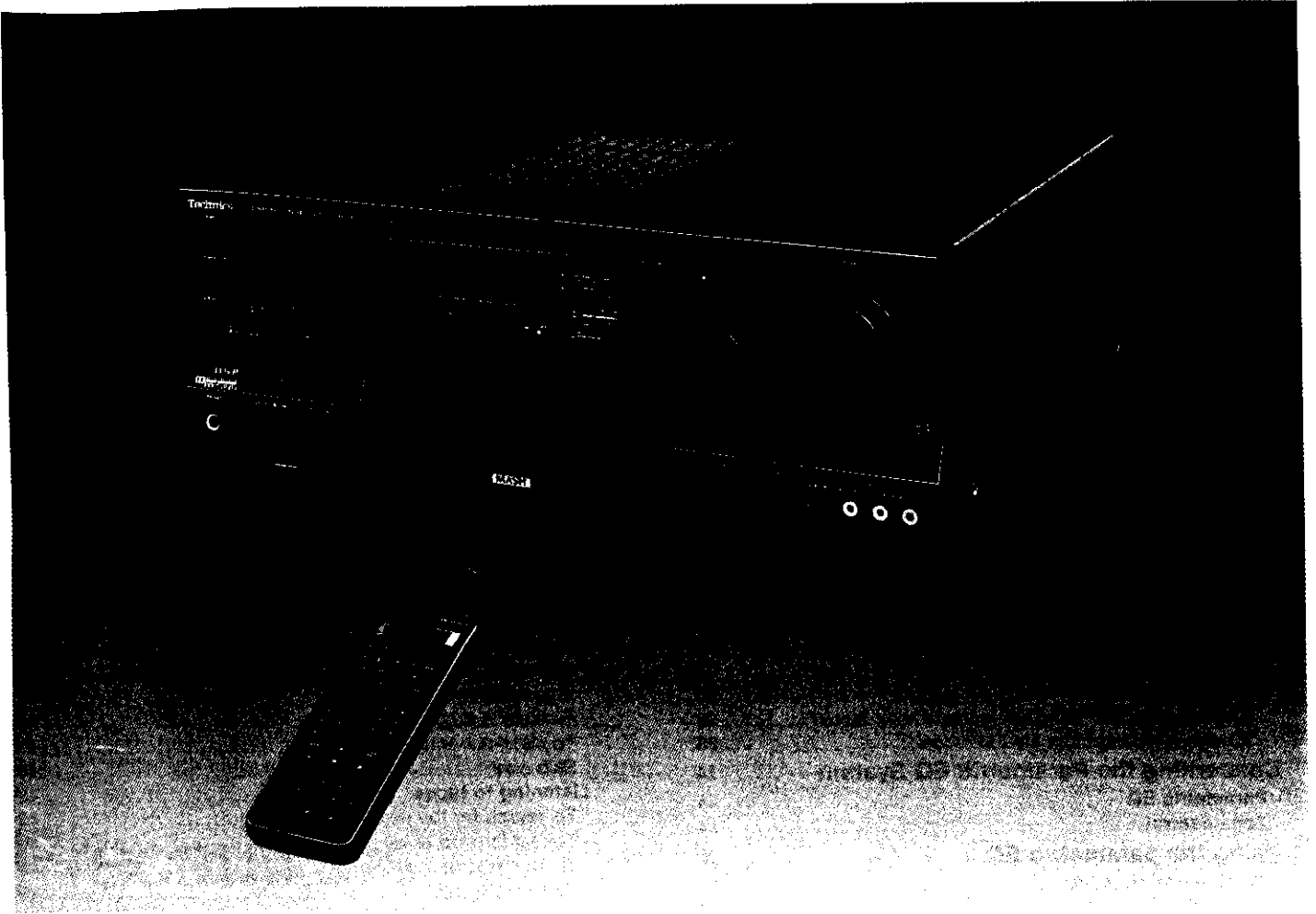

Before connecting, operating or adjusting this product,  
please read these instructions completely.

RQT1199-M

H0791C0

# Table of Contents

<b>Before Use</b> .....	3	<b>Using the Other Surround-Sound</b>	
<b>Precautions</b> .....	3	<b>(HALL, CLUB, STADIUM)</b> .....	35
<b>Safety</b> .....	3	<b>Enjoying the other surround-sound</b>	
<b>Installation</b> .....	4	<b>(HALL, CLUB, STADIUM)</b> .....	35
Environment .....	4	To adjust the volume level of the rear speakers .....	35
Placement .....	4	To adjust the delay time .....	35
<b>Maintenance</b> .....	4	<b>Using the Dolby 3 Stereo System</b> .....	36
<b>Service</b> .....	4	<b>Adjustment of each channel balance</b> .....	36
<b>Preparations</b> .....	5	<b>Enjoying Dolby 3 stereo sound</b> .....	37
<b>Supplied accessories</b> .....	5	<b>While listening to music</b> .....	38
<b>Rear panel terminals and functions</b> .....	5	<b>To emphasize low-frequency sound</b> .....	38
<b>Antenna connections</b> .....	8	<b>To adjust the left/right sound balance</b> .....	38
FM antenna connections .....	8	<b>Recording</b> .....	39
AM antenna connections .....	9	<b>Tape recording</b> .....	39
<b>Speaker connections</b> .....	10	To listen to the sound being recorded to the tape deck .....	39
Connection of speaker cables .....	10	<b>VCR (VCR 1 or VCR 2) recording</b> .....	39
<b>Front Panel Controls and Functions</b> .....	11	<b>Edit-Recording</b> .....	40
<b>Amplifier section</b> .....	11	<b>Edit recording from VCR 1 to VCR 2 and</b>	
<b>Tuner section</b> .....	13	<b>vice versa</b> .....	40
<b>Display section</b> .....	14	<b>Edit recording from VCR 3 to VCR 1 and/or VCR 2</b> .....	41
<b>Remote control section</b> .....	16	<b>Concerning the Remote Control</b> .....	42
<b>Basic Operating Procedure</b> .....	18	<b>Battery installation</b> .....	42
<b>To listen to a desired audio source while watching</b>		<b>Use of batteries</b> .....	42
<b>video picture</b> .....	19	<b>Operation notes</b> .....	42
<b>Using the S-video terminal for play back video</b>		<b>Remote-Control Operation (Audio)</b> .....	43
<b>cassettes or video discs</b> .....	19	<b>To switch each component's power ON/OFF</b> .....	43
<b>When listening through headphones</b> .....	19	<b>To attenuate the volume level</b> .....	43
<b>After use</b> .....	19	<b>To adjust the volume level</b> .....	43
<b>Listening to Radio Broadcasts</b> .....	20	<b>Listening to radio broadcasts</b> .....	44
<b>Manual tuner operation</b> .....	20	<b>Listening to compact discs</b> .....	45
If noise is excessive in the FM mode .....	20	<b>Sequential play</b> .....	45
<b>Memory presettings</b> .....	21	To stop play temporarily .....	45
Manual memory presetting .....	21	To stop play .....	45
Automatic memory presetting .....	22	Direct access play .....	46
Back-up memory .....	22	Program play .....	47
<b>Memory tuner operation</b> .....	23	To clear a program entry .....	47
Channel selection using the memory scan button .....	23	To clear the entire program .....	47
If noise is excessive in the FM mode .....	23	Skip play .....	48
<b>Concerning the Parametric EQ System</b> .....	24	<b>Listening to tapes</b> .....	49
<b>Parametric EQ</b> .....	24	To search for the desired tune .....	49
<b>Tone control</b> .....	24	To fast-forward or rewind the tape .....	49
<b>Using the parametric EQ</b> .....	25	To stop playback temporarily .....	49
<b>Demonstration mode</b> .....	25	To stop playback .....	49
Operation .....	25	<b>Recording on tape deck</b> .....	50
<b>Adjustment of the parametric EQ</b> .....	26	To make an unrecorded passage during recording .....	50
Fine adjustment of the center frequency .....	27	To stop recording temporarily .....	50
Characteristics of center frequency .....	27	To stop recording .....	50
<b>Storing a curve in memory</b> .....	28	<b>Listening to digital audio tapes</b> .....	51
<b>To recall a curve from memory</b> .....	28	To start playback from the desired tune .....	51
<b>To recall factory pre-programmed curves</b> .....	29	To fast-forward or rewind the tape .....	51
<b>Using the Tone Control</b> .....	30	To stop playback temporarily .....	51
<b>Adjustment of tone control</b> .....	30	To stop playback .....	51
<b>Concerning Sound Mode Operation</b> .....	31	<b>Recording on digital audio tape decks (DAT)</b> .....	52
<b>Surround-sound mode</b> .....	31	To make an unrecorded passage during recording .....	52
<b>Dolby 3 stereo mode</b> .....	31	To stop recording temporarily .....	52
<b>Positioning the speakers</b> .....	31	To stop recording .....	52
<b>Using the Dolby Pro-Logic Surround</b> .....	32		
<b>Adjustment of each channel balance</b> .....	32		
<b>Enjoying Dolby Pro-Logic Surround-sound</b> .....	33		
To adjust the delay time .....	33		
To adjust the input balance .....	34		

<b>Remote-Control Operation (Video)</b> .....	53	<b>Remote-Control Operation (Other unit control)</b> .....	61
<b>Watching TV broadcasts</b> .....	53	<b>Watching TV broadcasts</b> .....	61
<b>Watching video tapes</b> .....	54	<b>To control an RCA VCR or TV</b> .....	62
To stop playback temporarily .....	54	To return to Panasonic codes .....	62
To stop playback .....	54	<b>To control a Zenith VCR or TV</b> .....	63
To fast-forward or rewind the video tape .....	55	To return to Panasonic codes .....	63
<b>To activate the surround effect</b> .....	55	<b>Remote-Control Operation (Other functions)</b> .....	64
To adjust the rear volume level .....	55	<b>To enjoy "Direct Play"</b> .....	64
<b>Recording of TV broadcasts</b> .....	56	<b>To enjoy "Multi-Function Play"</b> .....	65
To stop recording temporarily .....	56	To program the multi-function keys .....	65
To stop recording .....	56	To stop programming .....	65
<b>Recording of video discs</b> .....	57	To alter the program .....	65
To stop recording temporarily .....	57	Suggested uses for programming .....	66
To stop recording .....	57	To operate .....	67
<b>Watching video discs</b> .....	58	<b>Code memorization</b> .....	68
To watch from the desired chapter number .....	58	About keys which have memory function .....	68
To stop playback temporarily .....	58	To memorize codes .....	69
To stop playback .....	58	<b>Code erasure</b> .....	70
Program play .....	59	To cancel one code at a time .....	70
To clear a program entry .....	59	To cancel by block .....	71
To clear the entire program .....	59	<b>Technical Specifications</b> .....	72
Skip play .....	60	<b>Troubleshooting Guide</b> .....	73
		<b>Product Service</b> .....	74
		<b>Product Information</b> .....	74
		<b>Index</b> .....	75

## Before Use

Be sure to disconnect the mains cord before adjusting the voltage selector.

Use a minus (-) screwdriver to set the voltage selector (on the rear panel) to the voltage setting for the area in which the unit will be used.

(If the power supply in your area is 117 V or 120 V, set to the "127 V" position.)

Note that this unit will be seriously damaged if this setting is not made correctly.

## Precautions

Before using this unit please read these operating instructions carefully. Take special care to follow the warnings indicated on the unit itself as well as the safety suggestions listed below.

Afterwards keep them handy for future reference.

## Safety

- 1. Power Source** -- The unit should be connected to power supply only of the type described in the operating instructions or as marked on the unit.
- 2. Polarization** -- If the unit is equipped with a polarized AC power plug (a plug having one blade wider than the other), that plug will fit into the AC outlet only one way. This is a safety feature. If you are unable to insert the plug fully into the outlet, try reversing the plug. If the plug should still fail to fit, contact your electrician to replace your obsolete outlet. Do not defeat the safety purpose of the polarized plug.
- 3. Power Cord Protection** -- AC power supply cords should be routed so that they are not likely to be walked on or pinched by items placed upon or against them. Never take hold of the plug or cord if your hand is wet, and always grasp the plug body when connecting or disconnecting it.
- 4. Nonuse Periods** -- When the unit is not used, turn the power off. When left unused for a long period of time, the unit should be unplugged from the household AC outlet.

# Precautions (continued)

## Installation

### Environment

1. **Outdoor Antenna Grounding** -- If an outside antenna is connected to the receiver, be sure the antenna system is grounded so as to provide some protection against voltage surges and built-up static charges. Section 810 of the National Electrical Code, ANSI/NFPA No. 70-1990, provides information with respect to proper grounding of the mast and supporting structure, grounding of the lead-in wire to an antenna discharge unit, size of grounding conductors, location of antenna-discharge unit, connection to grounding electrodes, and requirements for the grounding electrode. See figure below.

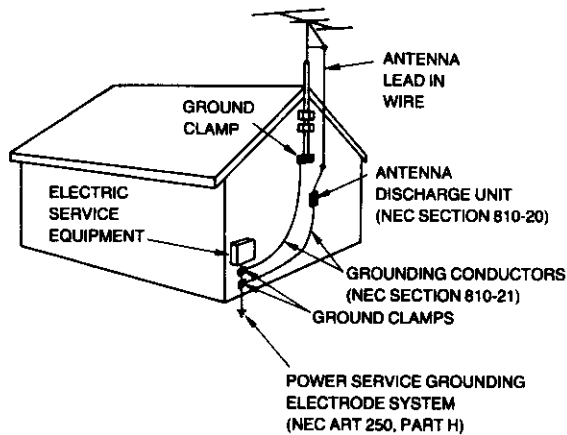

NEC—NATIONAL ELECTRICAL CODE

2. **Water and Moisture** -- Do not use this unit near water—for example, near a bathtub, washbowl, swimming pool, or the like. Damp basements should also be avoided.
3. **Heat** -- The unit should be situated away from heat sources such as radiators and the like. It also should not be placed in temperatures less than 5°C (41°F) or greater than 35°C (95°F).

### Placement

1. **Ventilation** -- The unit should be situated so that its location or position does not interfere with its proper ventilation. Allow 10 cm (4") clearance from the rear of the unit.
2. **Foreign Material** -- Care should be taken so that objects do not fall into and liquids are not spilled into the unit. Do not subject this unit to excessive smoke, dust, mechanical vibration, or shock.
3. **Magnetism** -- The unit should be situated away from equipment or devices that generate strong magnetism.
4. **Stacking** -- Do not place heavy objects, other than system components, on top of the unit.

5. **Surface** -- Place the unit on a flat, level surface.
6. **Carts and Stands** -- The unit should be used only with a cart or stand that is recommended by the manufacturer. The unit and cart combination should be moved with care. Quick stops, excessive force, and uneven surfaces may cause the unit and cart combination to overturn. 
7. **Wall or Ceiling Mounting** -- The unit should not be mounted to a wall or ceiling, unless specified in this operating instructions.

## Maintenance

Clean the cabinet, panel and controls with a soft cloth lightly moistened with mild detergent solution.

Do not use any type of abrasive pad, scouring powder or solvent such as alcohol or benzene.

## Service

1. **Damage Requiring Service** -- The unit should be serviced by qualified service personnel when:
  - (a) The AC power supply cord or the plug has been damaged; or
  - (b) Objects have fallen or liquid has been spilled into the unit; or
  - (c) The unit has been exposed to rain; or

- (d) The unit does not appear to operate normally or exhibits a marked change in performance; or
  - (e) The unit has been dropped, or the enclosure damaged.
2. **Servicing** -- The user should not attempt to service the unit beyond that described in the operating instructions. All other servicing should be referred to qualified service personnel.

# Preparations

## Supplied accessories

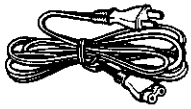

AC power supply cord (RJA0004) ..... 1 pc.

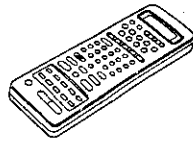

Remote control transmitter (EUR66636) ..... 1 pc.



Batteries AAA, 1.5 V (R03/UM-4) ..... 4 pcs.



Antenna plug ..... 1 pc. (SJS8202)

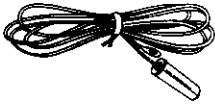

FM indoor antenna (SSA270M) ..... 1 pc.

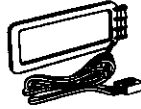

AM loop antenna (SPB1163T) ..... 1 pc.



AM antenna holder ..... 1 pc.



Screws ..... 2 pcs.



Power plug adaptor (SJP9215) ..... 1 pc.

## Rear panel terminals and functions

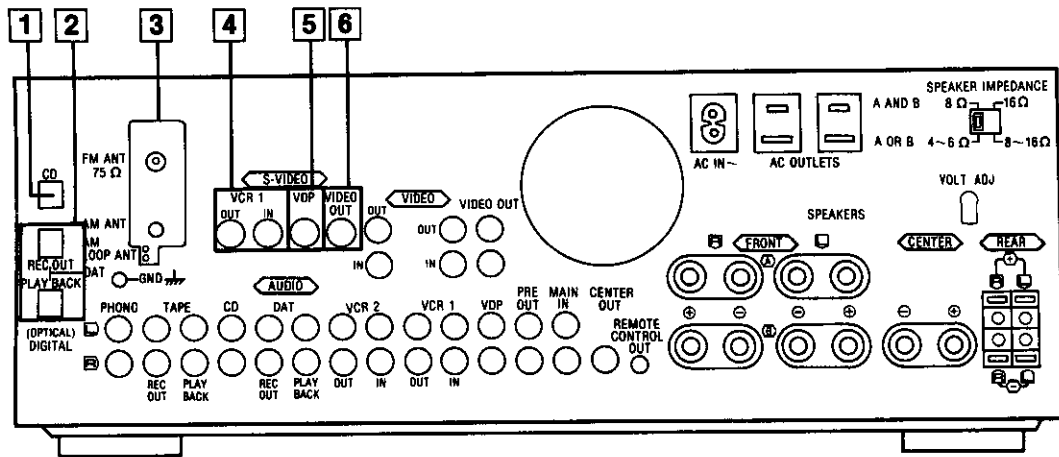

### 1 "CD" terminals (DIGITAL)

Connect an optical-fiber cable (not included) to the optical output terminal of the compact disc player. If this connection is made, the stereo connection cables do not need to be connected (refer to page 7).

### 2 "DAT" terminals (DIGITAL)

Connect a digital audio tape deck (DAT) by using optical-fiber cables (not included). If this connection is made, the stereo connection cables do not need to be connected (refer to page 7).

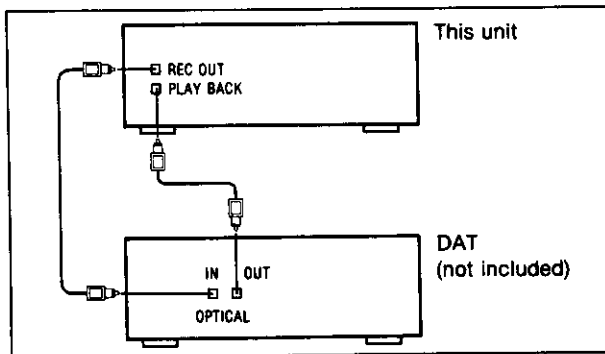

### 3 Antenna connection terminals

See pages 8-9 for detailed information.

### 4 S-video "VCR 1" terminals

Connect a VCR by using S video cables (not included).

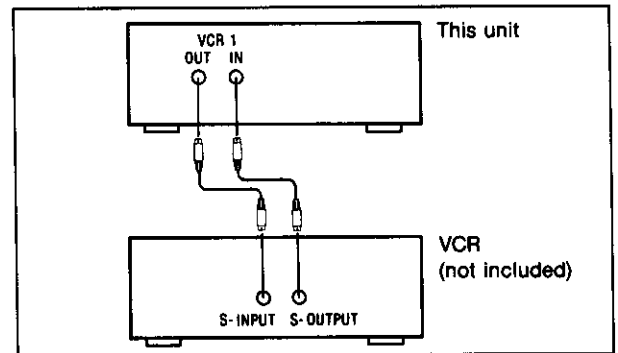

### 5 S-video "VDP" terminal

Connect an S video cable (not included) to the S output terminal of the video disc player.

### 6 S-video "VIDEO OUT" terminal

Connect an S video cable (not included) to the "S-VIDEO" input terminal of TV or projection TV.

(Continued on next page)

# Preparations (continued)

## Rear panel terminals and functions (continued)

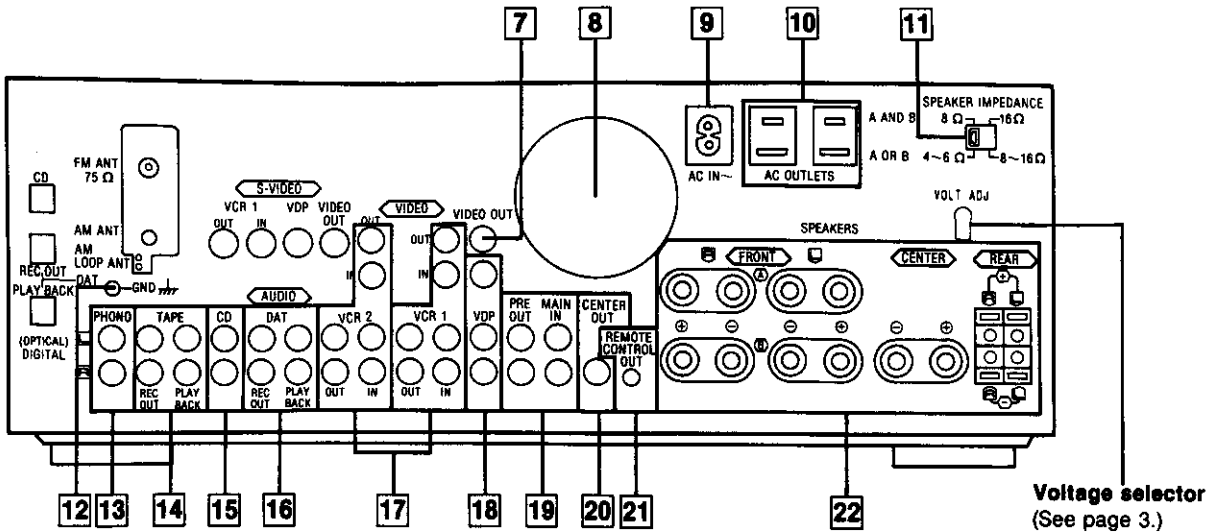

### 7 "VIDEO OUT" terminal

Connect a video connection cable (not included) to the video input terminal of TV or projection TV.

### 8 Cooling fan

The cooling fan operates at high output power levels only.

### 9 AC IN socket (AC IN)

Connect this socket to an AC outlet on the wall using the power supply cord.

If the power plug will not fit your socket, use the power plug adaptor (included).



### 10 Outlets "SWITCHED"

Power to these outlets is controlled by the power switch of this unit. Audio equipment rated up to 80 W (total for all outlets) can be connected here. For proper remote-control operation, connect the power cords of the tape deck and compact disc player to these outlets as indicated below:

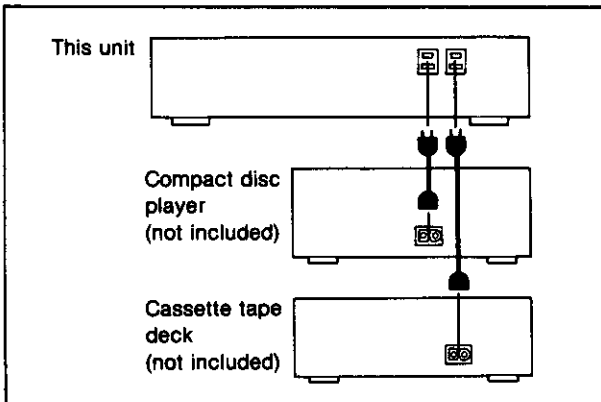

### 11 Speaker impedance selector

Before use, set to the correct impedance corresponding to the impedance of the speaker systems being used. (Refer to page 10.)

### 12 "GND" terminal

Connect the turntable's ground wire to this terminal (if applicable).

### 13 "PHONO" terminals

Connect a turntable only. Do not connect any other sound source to these terminals.

### 14 "TAPE" terminals

Connect a tape deck by using stereo connection cables (not included).

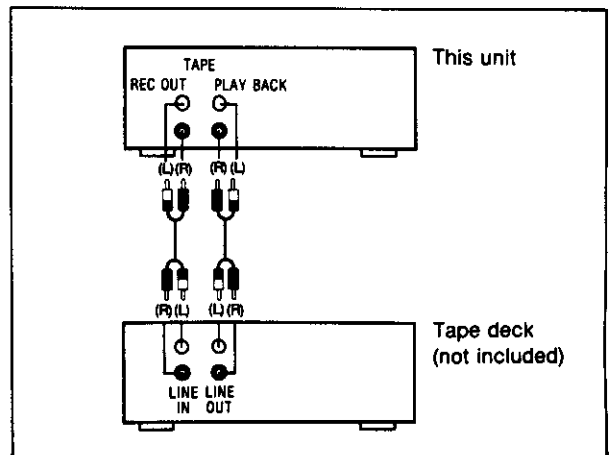

### 15 "CD" terminals

Connect a stereo connection cable (not included) to the "LINE OUT" terminal of the compact disc player.

### 16 "DAT" terminals

Connect a digital audio tape deck (DAT) by using stereo connection cables (not included).

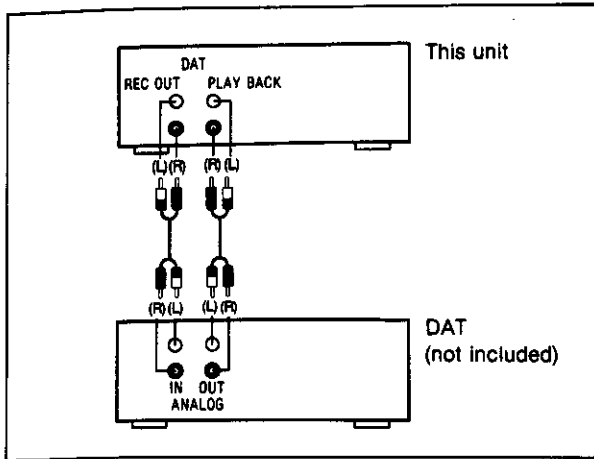

### 17 "VCR 1/VCR 2" terminals

Connect VCRs by using stereo connection cables (not included) and video connection cables (not included). The illustration below shows the VCR 1 connection.

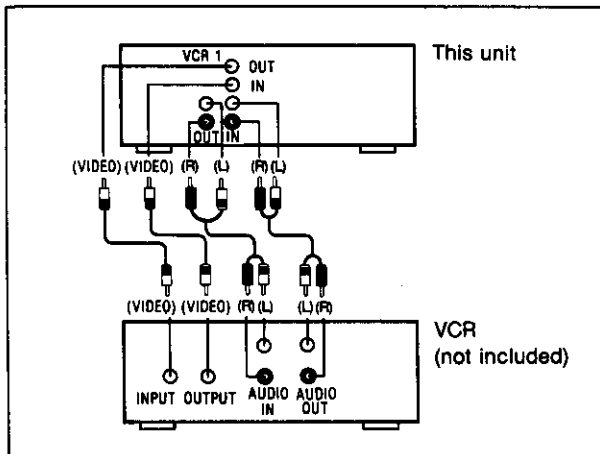

### 18 "VDP" terminals

Connect a video disc player by using stereo connection cables (not included) and video connection cables (not included).

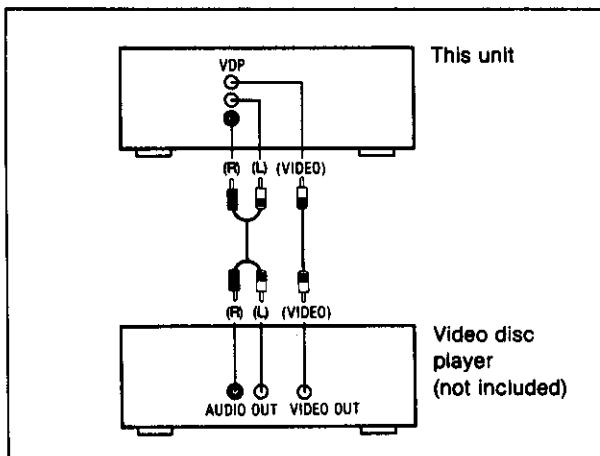

### 19 "PRE OUT/MAIN IN" terminals

Do not remove the shorting pins from these terminals unless you plan to use an independent preamplifier or main amplifier. (No sound will be heard if they are removed). To use it in this way, refer to the operating instructions for the additional amplifier or preamplifier that you plan to use.

### 20 "CENTER OUT" terminal

This terminal is connected to use the speakers connecting to the external amplifier or to use the TV speakers as the center speaker. Connect a Y-adaptor cable (not included) to the audio input terminal of the external amplifier or TV. When using the speakers, after setting the center level of the main unit to MAX, adjust the volume on the external amplifier or the TV.

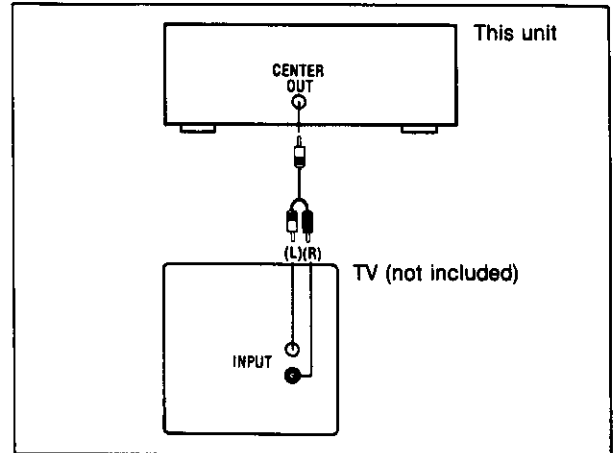

### 21 Remote-control OUT terminal (REMOTE CONTROL OUT)

This terminal can be used only with Technics components which have the appropriate remote-control terminal. (Consult your dealer for details.) Proper connection with remote-control connection cables SJP2257T will allow control of some functions from this unit's remote-control transmitter. (See pages 42-50 for details.) Connect to a tape deck and/or compact disc player as shown below.

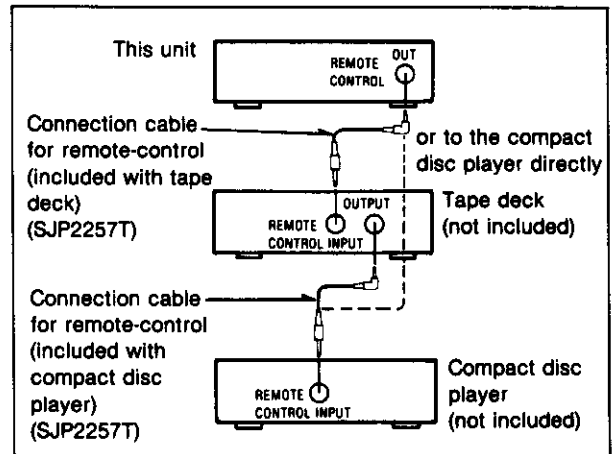

### 22 Speaker connection terminals

See page 10 for detailed information.

# Preparations (continued)

## Antenna connections

### FM antenna connections

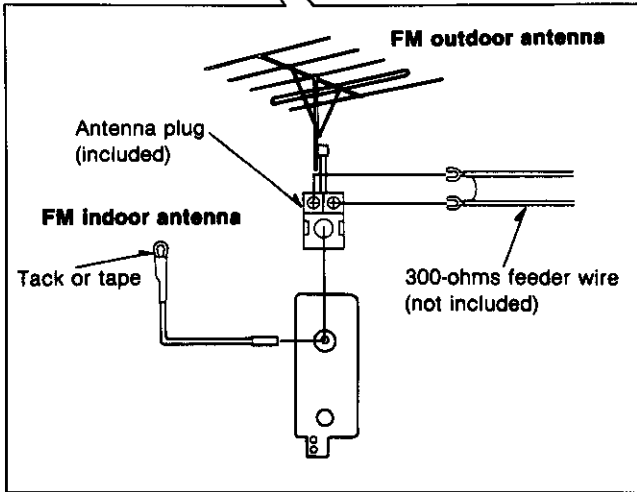
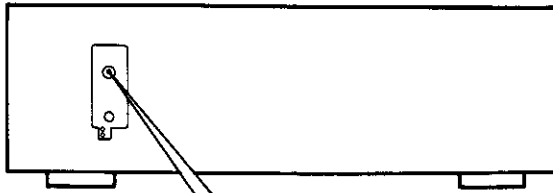

#### ■ FM indoor antenna (included)

Attach to a wall (using a tack or tape) facing in the direction of best reception.

#### For best reception sound quality:

An FM outdoor antenna is recommended.

- The tack should not contact the internal antenna wire.
- Disconnect the antenna if an FM outdoor antenna is installed.

#### ■ FM outdoor antenna (not included)

If the FM indoor antenna does not provide satisfactory reception, an outdoor antenna should be used.

The outdoor antenna may be required in a mountainous region, or if this unit is located inside a reinforced-concrete building, etc.

#### Connection wire from the antenna

Two types of wire are most commonly used for connection from the antenna: 300-ohms parallel feeder wire or 75-ohms coaxial cable. For best resistance to external interference noise, the use of 75-ohms coaxial cable is suggested.

#### How to connect a 75-ohms coaxial cable

- 1 Remove a piece of the outer vinyl insulator.

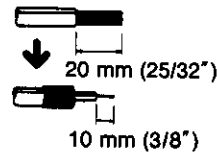

- 2 Press the tab and remove the cover.



- 3 Loosen the screw.

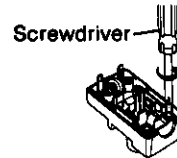

- 4 Install the coaxial cable.

- 1) Slide in the core wire
- 2) Tighten the screw

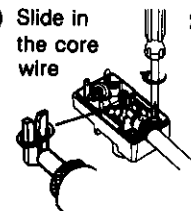

- 5 Remove the ring and place it on the pin at the back of the cover.

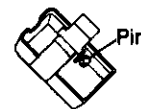
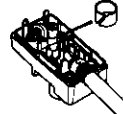

- 6 Attach the cover.

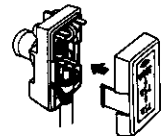

#### How to connect a 300-ohms feeder wire

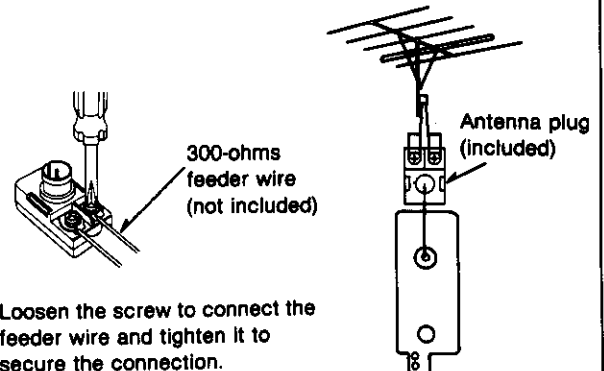

Loosen the screw to connect the feeder wire and tighten it to secure the connection.



## AM antenna connections

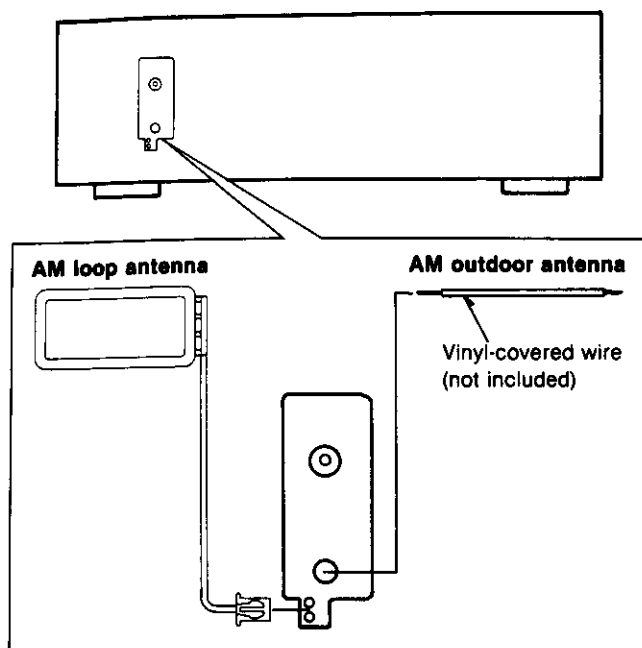

### ■ AM loop antenna (included)

Connect the AM loop antenna to the AM antenna terminals, and mount it vertically to a column, rack.

Move the antenna toward the right or left to find the point of best reception.

- If this antenna is not properly installed, AM broadcasts will not be received.
- Be sure to connect the AM loop antenna even when an outdoor antenna is used.

**Pay attention to the following points when mounting the antenna.**

- Do not mount it horizontally (Doing so will impair reception).
- Do not mount it close to power cords, speaker wires or metal surfaces (Doing so will result in noise).
- Do not mount it close to a tape deck. When the tape deck is being used, chirping or beeping sounds may result.

### When mounting the antenna to a column, a wall or rack

Mount it vertically.

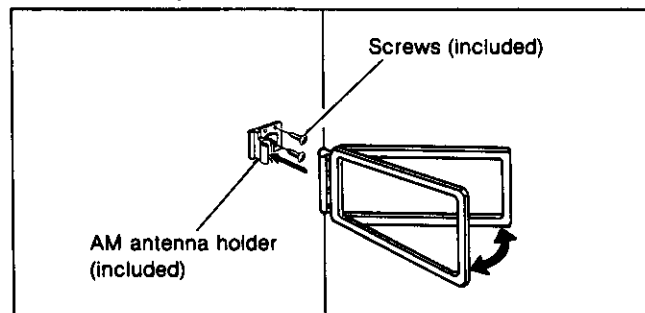

### When mounting the antenna to the unit

This type of installation may cause impaired reception or result in signal noise. If possible, mount the antenna to a rack, a wall, or a column.

Move the antenna toward the right or left to find the point of best reception.

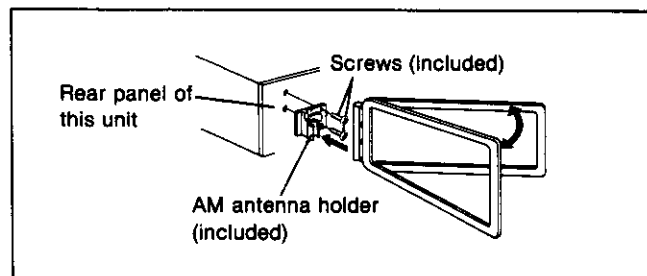

### ■ AM outdoor antenna (not included)

An outdoor antenna may be required in a mountainous region, or if this unit is located inside a reinforced-concrete building, etc.

Use 5–12 m (16–40 ft.) of vinyl-covered wire horizontally at the window, or convenient location.

When the unit is not in use, disconnect the outdoor antenna to prevent possible damage that may be caused by lightning. Never use an outdoor antenna during an electrical storm.

# Preparations (continued)

## Speaker connections

See page 31 regarding the positioning of the speakers.

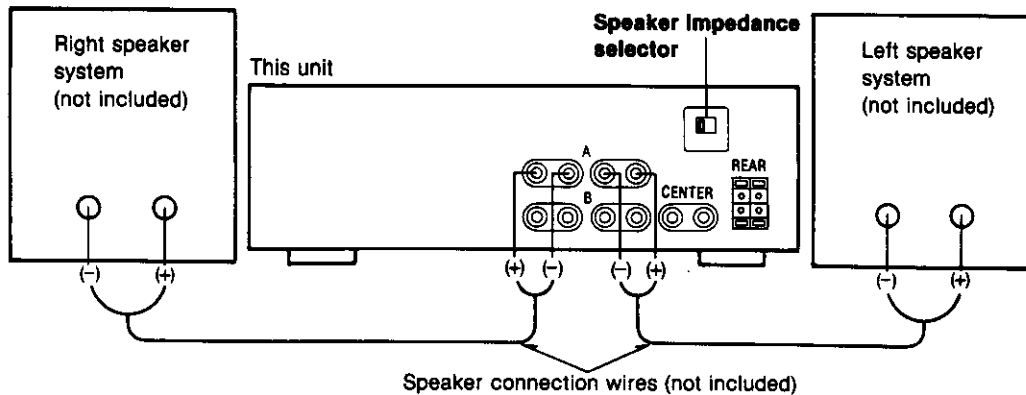

### "B" terminals

For connection to a second pair of speakers.

### "CENTER" terminals

For connection to center speakers.

### "REAR" terminals

For connection to rear speakers.

### Load impedance

**If either the "A" or the "B" speaker systems are used:**

Set the speaker impedance selector corresponding to the speaker systems being used.

**4~6 Ω:** For speaker impedance of 4~6 Ω.

**8~16 Ω:** For speaker impedance of 8~16 Ω.

### If both "A" and "B" speaker systems are used:

1) If the impedance of both systems is 16 Ω, set the speaker impedance selector to "16 Ω".

2) If the impedance of both systems is 8 Ω, or one is 8 Ω and the other is 16 Ω, set the speaker impedance selector to "8 Ω".

3) If the impedance of both systems is 4 Ω, both speakers can not be used at the same time.

### Note:

The load impedance of center and rear speakers must be 8~16 Ω.

## Connection of speaker cables

### For "A", "B" and "CENTER" terminals

- 1) Twist the core of the speaker wires.

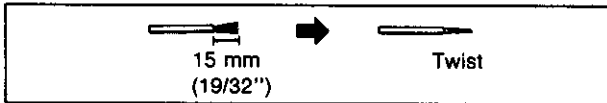

- 2) Turn counterclockwise 5 or 6 times to reveal hole in terminal shaft.



- 3) Insert the wire and tighten screw completely. Pull the wire to assure a proper connection.

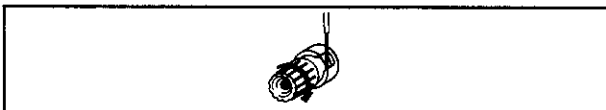

Be sure to only connect positive (+) wires to positive (+) terminals, and negative (-) wires to negative (-) terminals.

### Notes:

To prevent damage to circuitry, never short-circuit positive (+) and negative (-) speaker wires.

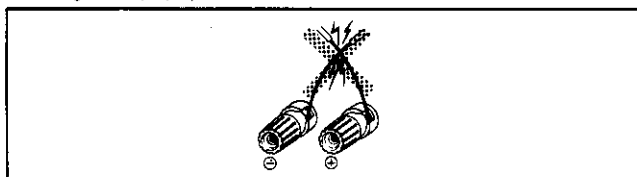

### For "REAR" terminals

- 1) Twist the core of the speaker wires.

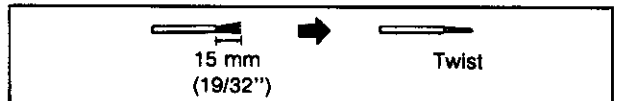

- 2) Open the lever, and insert the core until it can no longer be seen.

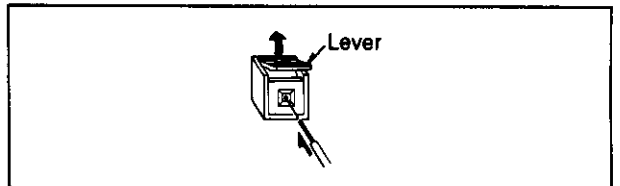

- 3) Close the lever, and pull the wire to assure a proper connection.

Be sure to only connect positive (+) wires to positive (+) terminals, and negative (-) wires to negative (-) terminals.

### Notes:

To prevent damage to circuitry, never short-circuit positive (+) and negative (-) speaker wires.

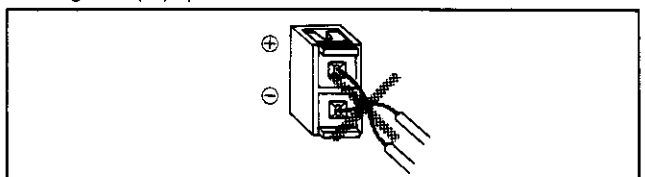

# Front Panel Controls and Functions

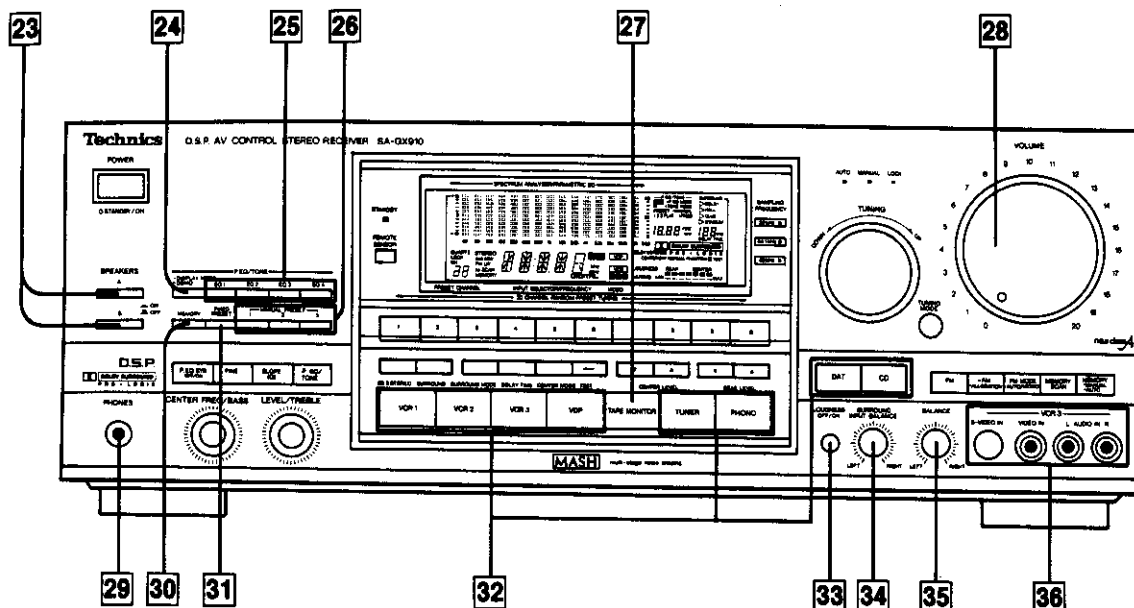

## Amplifier section

### 23 Speaker selectors (SPEAKERS)

These selectors are used to select the speaker system(s) (A and/or B).

### 24 Display mode select button (-DISPLAY MODE - DEMO)

This button is used to select either the spectrum analysis level ("Bar-type display" or "Dot display") or equalization level display.

If the button is pressed for 3 seconds or more, this unit will start a demonstration mode for the parametric EQ system. (Refer to page 25 for detailed information.)

### 25 Parametric EQ band select buttons

These buttons are used to select the band to be adjusted.

### 26 Equalization preset buttons (MANUAL PRESET)

These buttons are used for storing or recalling the curves made by the parametric EQ system.

### 27 Tape-monitor switch (TAPE MONITOR)

Press this button to listen to a tape or an audio source connected to the "TAPE" terminals.

To listen to some other source, press this button once again (so that the indicator is switched OFF).

### 28 Volume control (VOLUME)

### 29 Headphone Jack (PHONES)

### 30 Parametric EQ system memory button (MEMORY)

This button enables the curves to be stored in the parametric EQ system memory.

### 31 Fixed preset button (FIXED PRESET)

This button is used to recall a "fixed preset" curve from the main unit's memory.

### 32 Input selector buttons

These buttons are used to select the sound source to be heard, such as a disc, radio broadcasts, etc. The selected sound source is shown on the audio input selector/frequency display.

The "PHONO" input selector has two functions: when pressed momentarily it selects "PHONO". when pressed and held for about 3 seconds, it de-activates the muting function.

### 33 Loudness switch (LOUDNESS)

Set to the "ON" position (the loudness indicator will illuminate); when listening to music at low volume. Auditory perception of sound in the low frequency range falls off at low volume, but when the switch is in this position, this deficiency is compensated for, so that the full impact of the musical performance can be enjoyed.

### 34 Dolby surround input balance control (SURROUND INPUT BALANCE)

This control is used to minimize dialogue leakage in the surround channel thereby optimizing the Dolby surround decoding operation.

### 35 Balance control (BALANCE)

### 36 "VCR 3" terminals (VCR 3)

These terminals are used for tape-to-tape recording if a third VCR is connected here.

# Front Panel Controls and Functions

(continued)

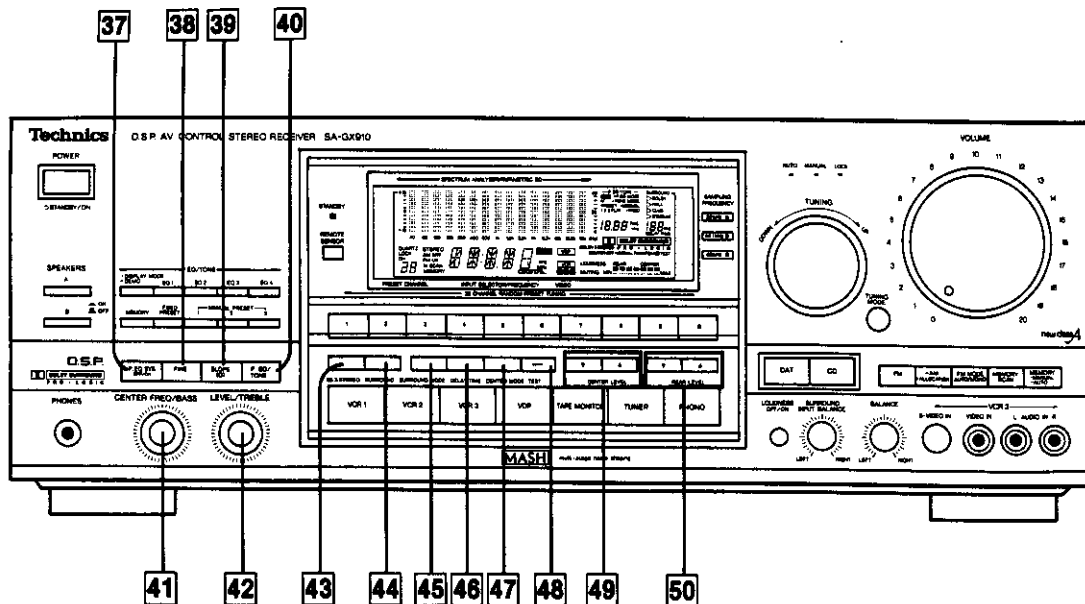

## Amplifier section (continued)

### **37** Parametric EQ system ON/OFF button (P. EQ SYS)

This button is used to turn the parametric EQ system ON or OFF.

### **38** Fine mode select button (FINE)

This button is used to fine-adjust the center frequency of the parametric EQ.

### **39** Slope changeover button [SLOPE (Q)]

This button is used to increase or decrease the slope of the parametric EQ curves.

### **40** Parametric EQ/tone mode select button (P.EQ/TONE)

This button is used to select parametric EQ mode or tone mode.

### **41** Center frequency select/bass control (CENTER FREQ/BASS)

This control is used to select the center frequency in the parametric EQ mode or to adjust the low-frequency sounds in the tone mode.

### **42** Frequency level/treble control (LEVEL/TREBLE)

This control is used to adjust the frequency level in the parametric EQ mode or the high-frequency sounds in the tone mode.

### **43** Dolby 3 stereo ON/OFF button (3 STEREO)

This button is used to activate the Dolby 3 stereo effect.

### **44** Surround ON/OFF button (SURROUND)

This button is used to activate the surround effect.

### **45** Surround mode select button (SURROUND MODE)

This button is used to select the desired surround mode.

### **46** Delay time adjustment button (DELAY TIME)

### **47** Center mode select button (CENTER MODE)

Each time you press this button, the center mode will change as follows: NORMAL → PHANTOM → CENTER OFF.

### **48** Test signal transmission button (TEST)

When using the center speaker and the rear speakers, press this button to activate the test signal. Then adjust the volume balance of the center speaker and rear speakers.

### **49** Center speaker level adjustment buttons (CENTER LEVEL)

These buttons are used to adjust the volume level of the center speaker.

### **50** Rear speaker level adjustment buttons (REAR LEVEL)

These buttons are used to adjust the volume level of the rear speakers.

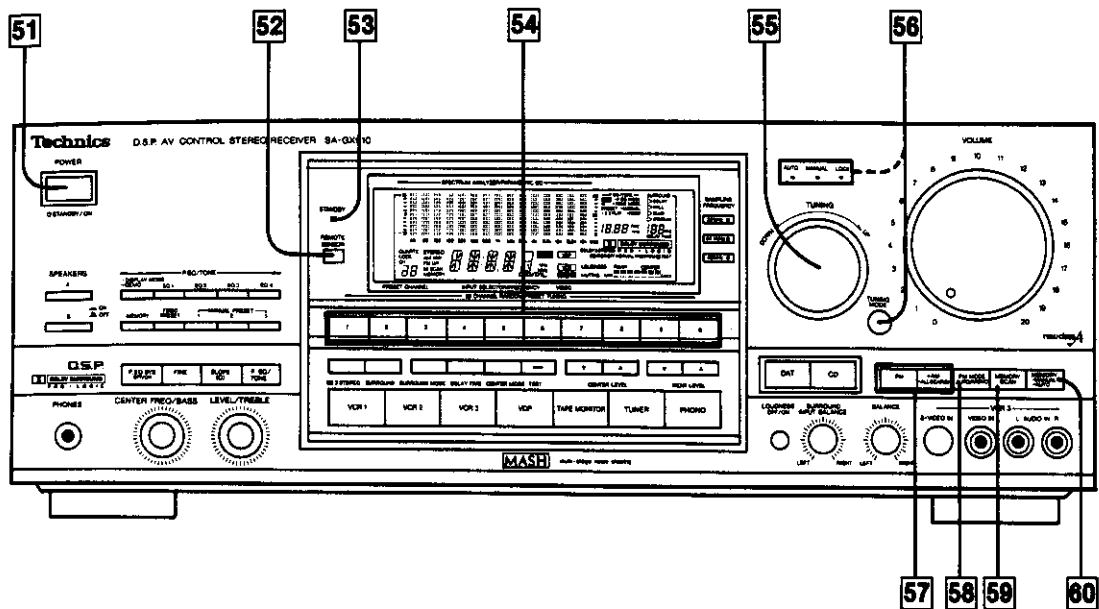

## Tuner section

### 51 Power "⏻ STANDBY/ON" switch (POWER, ⏻ STANDBY/ON)

This switch switches ON and OFF the secondary circuit power only. The unit is in the "standby" condition when this switch is set to the ⏻ STANDBY position. Regardless of the switch setting, the primary circuit is always "live" as long as the power cord is connected to an electrical outlet.

### 52 Remote-control signal receptor (REMOTE SENSOR)

Receives the signals from the remote-control.

### 53 "STANDBY" Indicator (STANDBY)

This indicator illuminates when the power switch of this unit or that of the remote-control is switched "OFF". Its purpose is to alert the user of the constant supply voltage to the internal circuitry even with the power switch OFF.

### 54 Preset-tuning buttons (1-0) (30 CHANNEL RANDOM PRESET TUNING)

These buttons are used to preset broadcast frequencies into the memory of this unit and to recall the desired preset stations. (Refer to pages 21-23.)

### 55 Tuning control (TUNING)

This control is used to select an FM or AM broadcast. When turning the control to the left, the frequency changes downward. When turning the control to the right, the frequency changes upward.

### 56 Tuning-mode selector/indicator (TUNING MODE)

Each time this selector is pressed, the selection changes, in sequence, to "AUTO", "MANUAL" and "LOCK".

#### AUTO:

In this position, broadcast channels are automatically selected when the tuning control is momentarily turned to the left or right to start the frequency changing.

#### MANUAL:

In this position, the tuning control can be used to locate the desired channel manually.

The frequency changes only as the tuning control is turned to the right or left.

#### LOCK:

In this position, the broadcast channel presently being heard is locked in, and other broadcast stations cannot be tuned to, even if the tuning control is turned.

### 57 Band selectors

**FM:** Press this button to listen to an FM broadcast.

**AM:** Press this button to listen to an AM broadcast.

This button is also used to select the frequency step for AM broadcasts. After an AM broadcast is received, when this button is pressed continuously for about 3 seconds, the AM frequency step will change to 10 kHz. (This unit is set to 9 kHz before shipment.) In order to return to the original frequency step, press this button for about 3 seconds again.

### 58 FM mode selector (FM MODE)

This unit automatically switches to the stereo mode when an FM stereo broadcast is received. This selector is used to select the mode (stereo or monaural) of FM broadcast signals.

### 59 Memory scan button (MEMORY SCAN)

This button is used to locate a desired broadcast station; each broadcast station is selected for about 3 seconds.

### 60 Memory button (MEMORY)

This button is used when presetting broadcast station frequencies into memory. (Refer to page 21.)

# Front Panel Controls and Functions

(continued)

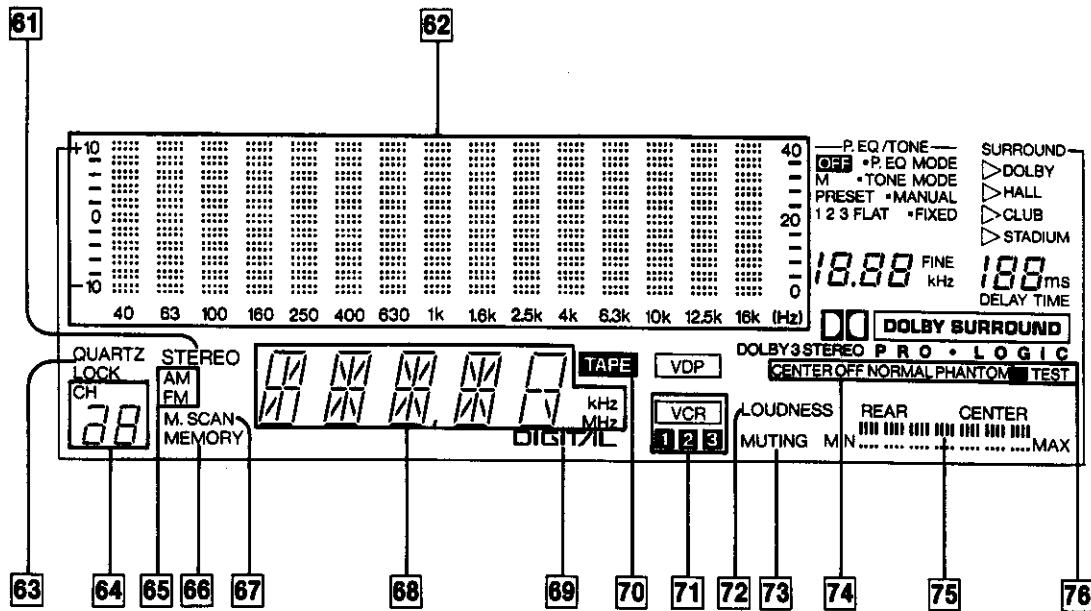

## Display section

### 61 FM stereo indicator (STEREO)

This indicator automatically illuminates when an FM stereo broadcast is being received.

#### Note:

It will not illuminate if the FM mode selector is set to the monaural mode.

### 62 Spectrum analysis/parametric EQ level display (SPECTRUM ANALYZER/PARAMETRIC EQ)

This display shows the spectrum analysis level ("Bar-type display" or "Dot display") or equalization level.

### 63 Quartz-lock indicator (QUARTZ LOCK)

This indicator illuminates when the unit is tuned precisely to a broadcast station.

### 64 Channel display

This display shows the channel number selected by one of the preset-tuning buttons.

Also this display shows the channel number for about 3 seconds during memory scan operation.

### 65 Band indicators (AM/FM)

Indicates the selected band.

### 66 Memory indicator (MEMORY)

This indicator illuminates when the memory button is pressed.

### 67 Memory scan indicator (M. SCAN)

This indicator illuminates when the memory scan button is pressed.

### 68 Audio input selector/frequency display (INPUT SELECTOR/FREQUENCY)

Displays the selected source or broadcast frequency.

### 69 Digital indicator

This indicator will illuminate when listening to compact discs or digital audio tapes through optical-fiber cable connections.

### 70 Tape indicator (TAPE)

This indicator will illuminate when the tape-monitor switch is pressed.

### 71 VCR display (VCR)

This display shows the VCR to be used.

### 72 Loudness indicator (LOUDNESS)

This indicator will illuminate when the loudness switch is pressed.

### 73 Muting indicator (MUTING)

This indicator will illuminate when the muting button (on the remote-control transmitter) is pressed.

### 74 Center mode indicators

These indicators show the center mode selected by the center mode select button.

### 75 Rear/center level indicator

Displays the level adjusted by the center speaker level adjustment button or rear speaker level adjustment button.

### 76 Test signal indicator (TEST)

This indicator illuminates when the test signal transmission button is pressed in the Dolby Pro-Logic Surround mode and the Dolby 3 stereo mode.

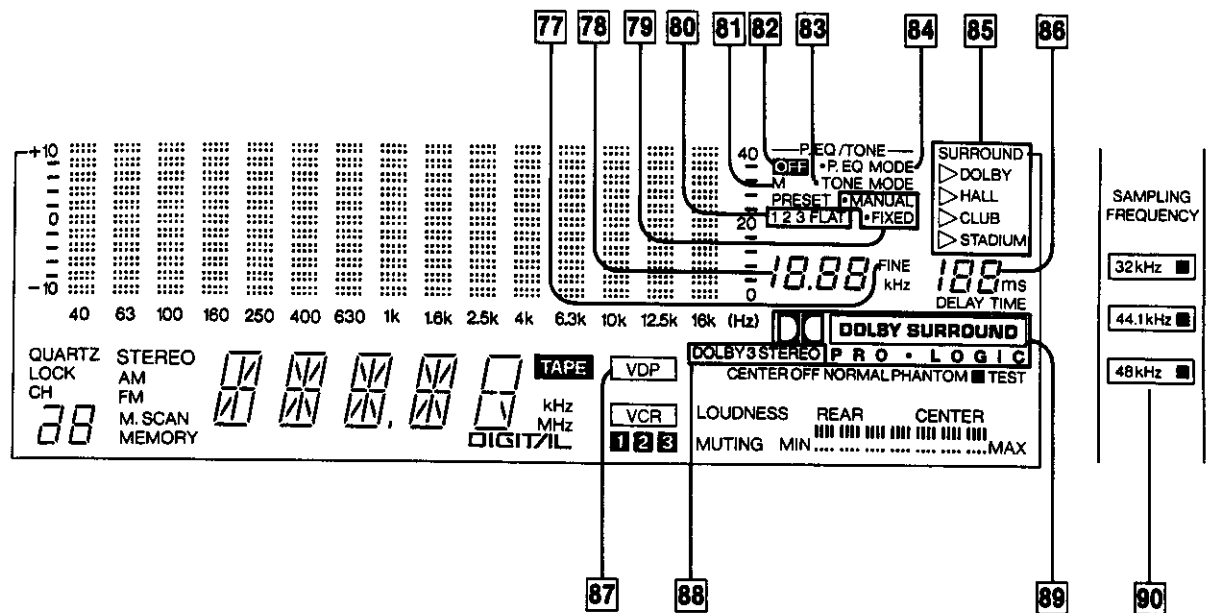

**77 Fine mode indicator (FINE)**

This indicator illuminates when the fine mode select button is selected in the parametric EQ mode.

**78 Parametric EQ system center frequency display**

It displays the center frequency of the curves in the parametric EQ mode arranged by the user with the parametric EQ system or the curves pre-stored in this unit's memory.

**79 Parametric EQ system operation select indicators (MANUAL/FIXED)**

One of these indicators will illuminate in accordance with the fixed preset button or equalization preset buttons setting.

**80 Manual/flat preset indicators (1 2 3 FLAT)**

It displays the type of curve selected with the equalization preset buttons or fixed preset button in the parametric EQ mode.

**81 Parametric EQ system memory indicator (M)**

This indicator illuminates when the parametric EQ system memory button is pressed in the parametric EQ mode.

**82 Parametric EQ system off indicator (OFF)**

This indicator illuminates when the parametric EQ system is off.

**83 Tone mode indicator (TONE MODE)**

This indicator illuminates when the parametric EQ/tone mode select button is set to the tone mode.

**84 Parametric EQ mode indicator (P.EQ MODE)**

This indicator illuminates when the parametric EQ/tone mode select button is set to the parametric EQ mode.

**85 Surround mode display (SURROUND)**

This display shows the surround mode selected by the surround mode select button.

**86 Delay time display (DELAY TIME)**

This display shows the length of the delay time selected for the surround feature.

**87 VDP Indicator (VDP)**

This indicator illuminates when the input selector marked "VDP" is pressed.

**88 Dolby 3 stereo indicator (DOLBY 3 STEREO)**

This indicator illuminates when the Dolby 3 stereo ON/OFF button is switched ON.

**89 Dolby Pro-Logic Surround indicator (DOLBY SURROUND PRO-LOGIC)**

This indicator illuminates when the Dolby Pro-Logic Surround mode is selected.

**90 Sampling frequency indicators (SAMPLING FREQUENCY)**

The appropriate indicator will illuminate whenever a digital signal with one of the sampling frequencies listed below is detected at a "DIGITAL" terminal on the rear panel of this unit.

**32 kHz:** For digital signals with the sampling frequency of 32 kHz mode

**44.1 kHz:** CD and others

**48 kHz:** For digital signals with the sampling frequency of 48 kHz mode

**Note:** Some digital components (compact disc player, etc.) emit digital signals whenever their power switches are "on".

# Front Panel Controls and Functions

(continued)

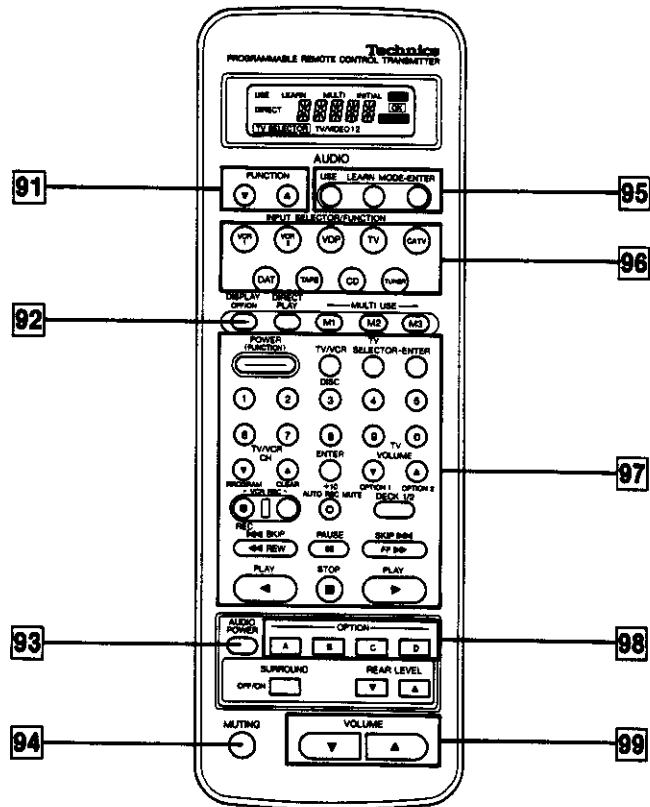

## Remote control section

### 91 Function select keys

These keys are used to select the component to be controlled by this remote-control transmitter.

### 92 Display OFF/ON key

This key is used to switch ON or OFF the display of this remote-control transmitter. It automatically goes "OFF" when the display is not used for approximately 18 minutes.

### 93 Audio power key

This key is used to switch ON or OFF the power of the receiver.

### 94 Muting key

This key is used to temporarily reduce the volume level. The volume level is attenuated by 20 dB (approx. 1/10). Press once again to resume to the previous volume level.

### 95 Operation mode select keys

These keys are used to select the operation mode to be operated by this remote-control transmitter.

**USE:** Select the "USE" key to set this remote-control transmitter for normal operation.

**LEARN MODE:** Select the "LEARN MODE" key to set this remote-control transmitter to the "LEARN" mode.

**ENTER:** Select the "ENTER" key to select the mode. (See item 101.)

### 96 Input/function select keys

These keys are used to select the input source at the component and to select the component to be controlled by this remote-control transmitter.

### 97 Operation keys

These keys are used to select the desired function of the selected component.

### 98 Optional keys

These keys are used to memorize a code to be used frequently. (See page 68.)

### 99 Volume keys

These keys are used to adjust the volume level.



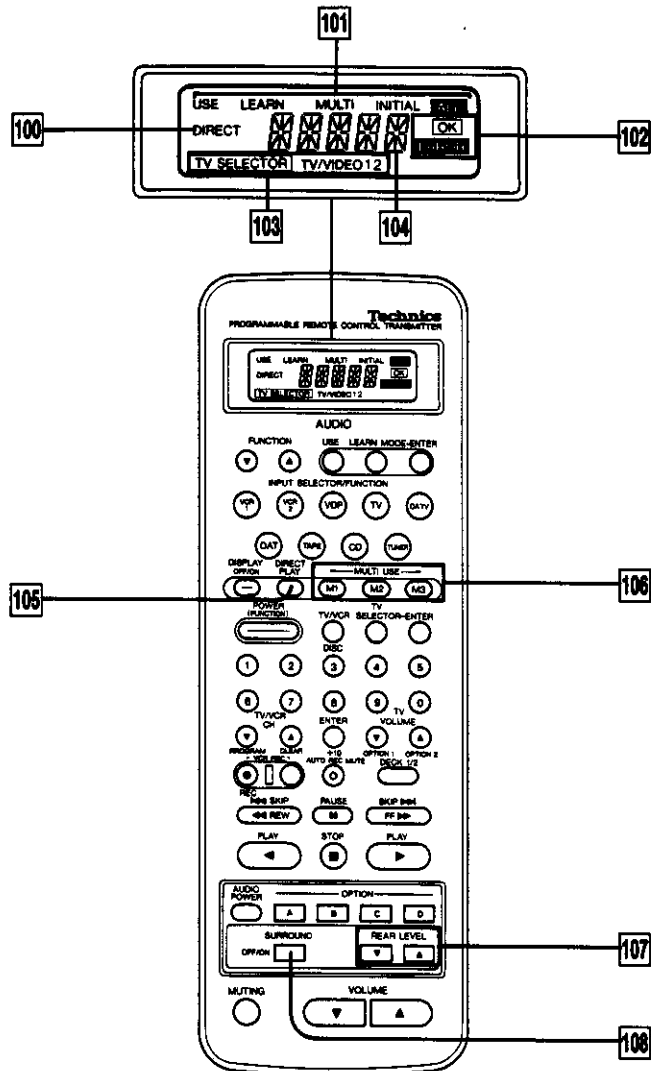

**100 Direct Indicator**

This indicator illuminates when this remote-control transmitter is set to the "DIRECT PLAY" mode.

**105 Direct play key**

This key is used to change this remote-control transmitter to the "DIRECT PLAY" mode.

**101 Operation mode Indicators**

One of these indicators shows the operation mode to be operated by this remote-control transmitter.

**106 Multi-function keys**

These keys are used to memorize a series of codes (up to 8 codes) and transmit these codes in a single operation. (See pages 65 and 67.)

**102 OK/ERROR Indicators**

**103 TV input indicator**

**107 Rear speaker volume keys**

These keys are used to adjust the volume level of the rear speaker systems.

**104 Component display**

This display shows which of the component functions has been selected.

The display shows "FULL" if memory capacity is exceeded when signals from another remote-control transmitter are memorized.

**108 Surround ON/OFF key**

This key is used to activate the surround effect. When this key is switched OFF, no sound will be heard from the center speaker and surround speaker systems.

# Basic Operating Procedure

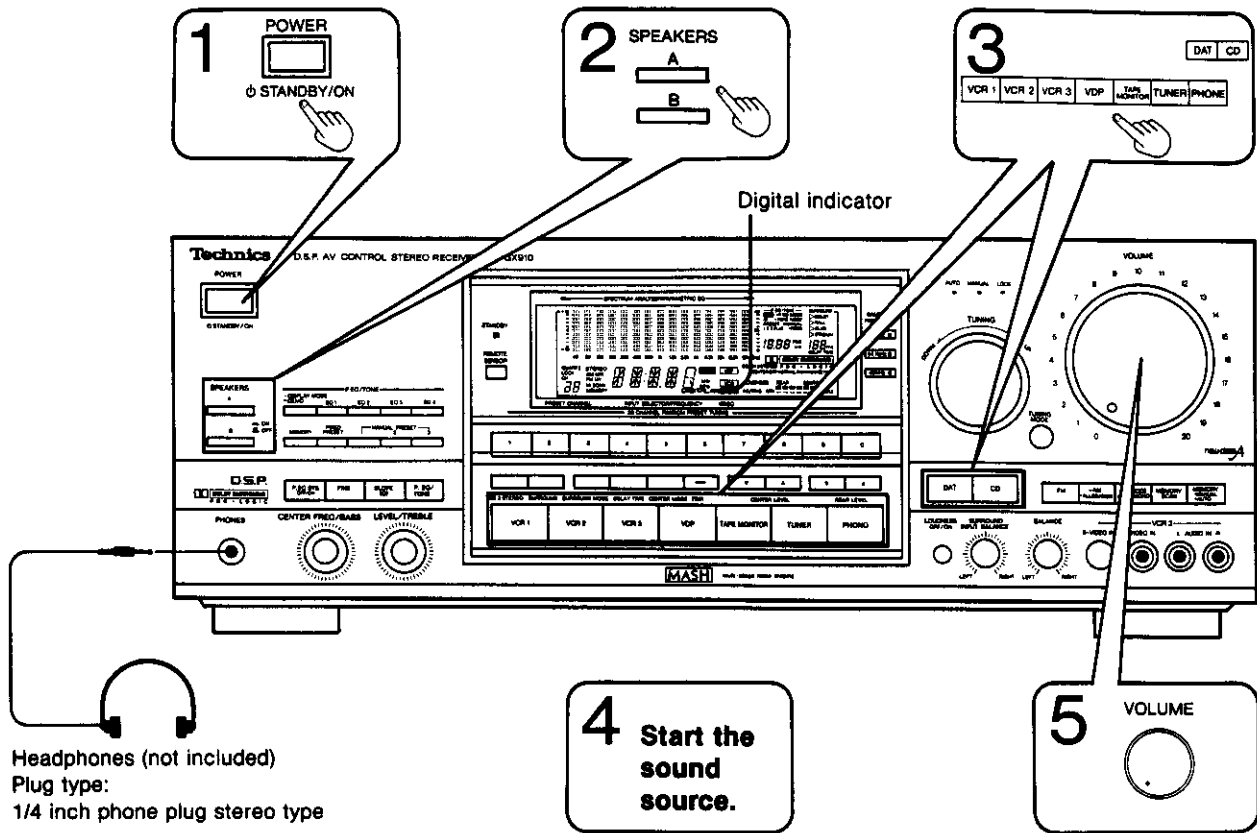

- 1 Set the power switch to ON.
- 2 Select the "A" and/or "B" speaker system(s) to be used.

### 3 Select the audio or video source.

- VCR 1:** Press this button to watch video tapes from the VCR connected to the "VCR 1" terminals.
- VCR 2:** Press this button to watch video tapes from the VCR connected to the "VCR 2" terminals.
- VCR 3:** Press this button to watch video tapes from the VCR connected to the "VCR 3" terminals on the front panel.
- VDP:** Press this button to watch video discs from the video disc player connected to the "VDP" terminals.
- TAPE MONITOR:** Press this button to listen to tape. No other sources selected by the input selector can be heard while the tape indicator is illuminated. To listen to some other source, press this button once again.
- TUNER:** Press this button to listen to radio broadcasts.
- PHONO:** Press this button to listen to phono discs.
- DAT:** Press this button to listen to digital audio tape.
- CD:** Press this button to listen to compact discs.

When the compact disc player and digital audio tape deck are connected to this unit by using an optical-fiber cable (not included), the digital indicator will illuminate by pressing the "DAT" or "CD" input selector.

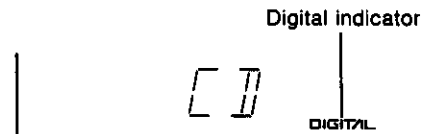

#### Note:

It is recommended that the power to the compact disc player be switched OFF when it is not being used.

- 4 Start the audio or video source.  
(Refer to the appropriate operating instructions for details).
- 5 Adjust the volume level.

## To listen to a desired audio source while watching video picture

---

Refer to page 18 and follow the procedure below.

- 1 Follow steps 1~2 on page 18.
- 2 Select the desired video source and audio source in step 3.  
Be sure to select the video source first.
- 3 Start the video and audio source.

## Using the S-video terminal for play back video cassettes or video discs

---

This unit is equipped with three S-video terminals: "VCR 1", "VDP" and "VIDEO OUT". Connection to the S-video terminals of the VCR results in a clearer and sharper picture than using the ordinary terminals.

Relating operations are shown on the left page. The TV input should be set to "S-video". (Refer to the TV operating instructions for details.)

## When listening through headphones

---

Use the volume control to reduce the volume level, and connect the headphones to the headphones jack.  
If sound from the speakers is not wanted, set the speaker selectors ("speakers") to the "off" position.

Set the Dolby 3 stereo ON/OFF button and surround ON/OFF button to OFF when the center speaker and rear speakers are connected.  
Avoid listening for prolonged periods of time to prevent hearing damage.

## After use

---

Be sure to reduce the volume level, and switch OFF the power from the remote-control transmitter or by the power switch of this unit.

**Note:** The input selection and the muting settings will be retained (as they were at the time when the power was switched OFF) by the memory back-up function.

# Listening to Radio Broadcasts

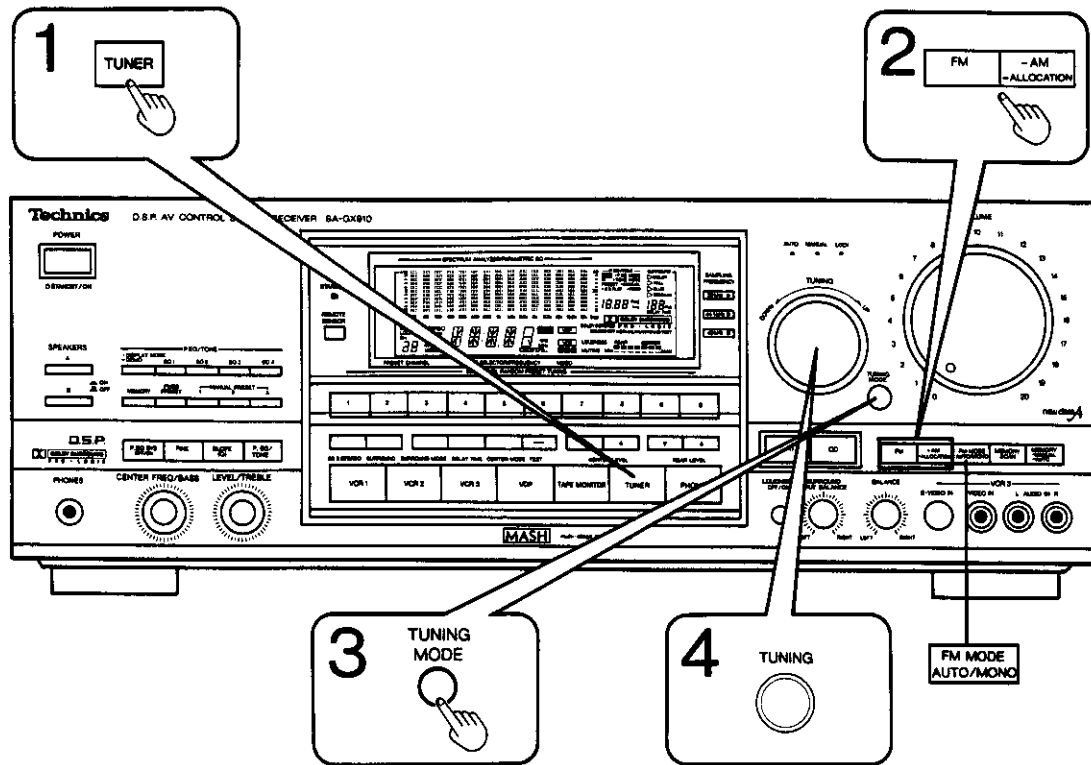

## Manual tuner operation (to listen to broadcasts by using the tuning control)

Have you completed the steps (on page 18) of "Basic Operating Procedure" ?

- 1 Press the "TUNER" button.**
- 2 Press the "FM" or "AM" button.**  
Before tuning AM broadcast stations, press to select the appropriate frequency step for your locality. (Refer to item **57** on page 13.)
- 3 Select the desired tuning mode, "AUTO" or "MANUAL".**
- 4 Turn the tuning control so as to tune to the desired broadcast.**  
In "AUTO" mode, the next station, higher or lower in broadcast frequency, will be automatically tuned in.  
In "MANUAL" mode, the frequency will change, using the smallest step available, only as the tuning control is being turned. This will allow you to tune in all of the broadcast frequencies available in that band.

If you want to lock the broadcast channel presently being heard, press the tuning-mode selector to select the "LOCK" position.

## If noise is excessive in the FM mode

Press the FM mode selector.



The sound will then be heard in monaural and the FM stereo indicator will not illuminate. If the broadcast signal is weak, or if there is a large amount of interference, sounds can be heard more clearly.

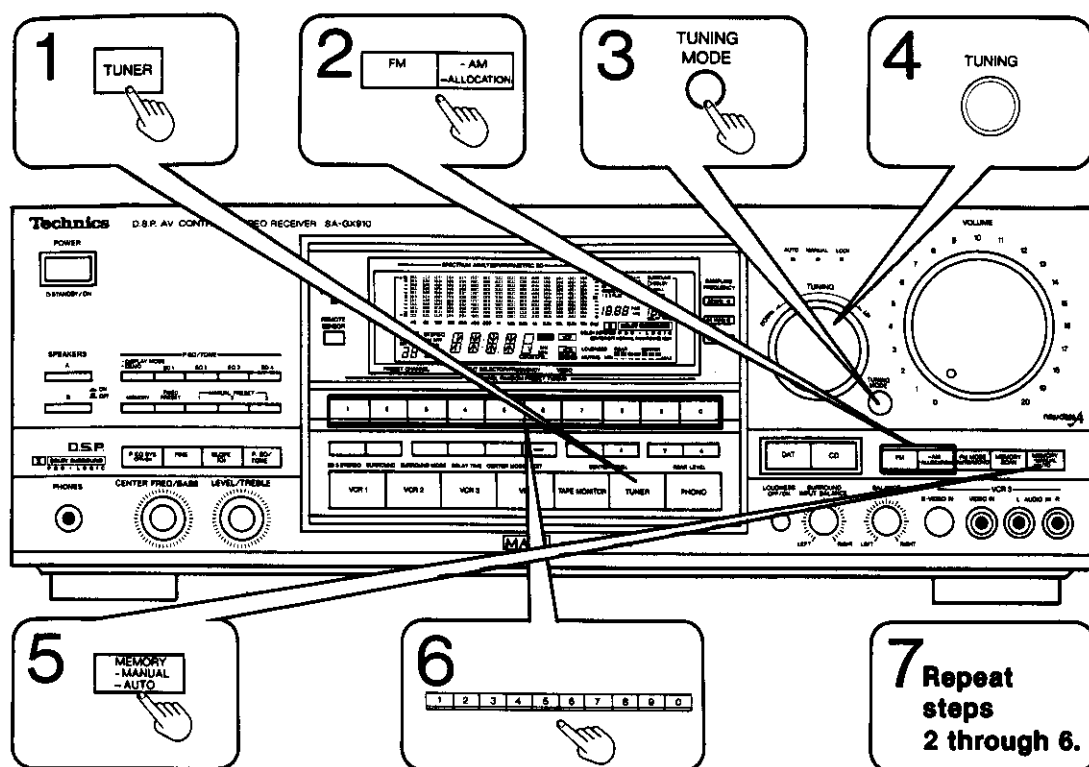

## Memory presettings

### Manual memory presetting

Have you completed the steps (on page 18) of "Basic Operating Procedure" ?

You can program 30 AM/FM radio broadcast stations into memory, so that any desired station may be selected by simply touching one or two buttons. (See pages 21~23.)

**1 Press the "TUNER" button.**

**2 Press the "FM" or "AM" button.**

Before presetting AM broadcast stations, press to select the appropriate frequency step for your locality. (Refer to item **57** on page 13.)

**3 Select the desired tuning mode, "AUTO" or "MANUAL".**

**4 Turn the tuning control so as to tune to the desired broadcast.**

In "AUTO" mode, the next station, higher or lower in broadcast frequency, will be automatically tuned in.

In "MANUAL" mode, the frequency will change, using the smallest step available, only as the tuning control is being turned. This will allow you to tune in all of the broadcast frequencies available in that band.

**5 Press the memory button momentarily.**  
(The memory indicator will illuminate.)

If the memory button is pressed and held until the frequency begins to change, the automatic memory presetting (See page 22.) is activated. To stop the automatic memory presetting, once again press the memory button. Then begin again from step 4.

To cancel the memory function, press the memory button again.

**6 Select the desired "CHANNEL".**

**To designate channels 1-9:**

Press the appropriate (1-9) preset-tuning button.

**To designate channels 10-30:**

① Press the button for the most significant digit (1, 2 or 3).

② Press the button for the least significant digit (1-0) within 2 seconds after pressing the first button.

If the interval between pressing the first button and pressing the second button is more than about 2 seconds, the setting may not be made correctly. If this happens, make the setting once again (following step 5).

**7 Repeat steps 2 through 6 to make additional memory presettings; for later reference, note the presettings in the station memory file on page 23.**

**Note:**

If a new broadcast station is preset into a channel, the broadcast station which was previously entered in that channel will be automatically erased.

# Listening to Radio Broadcasts (continued)

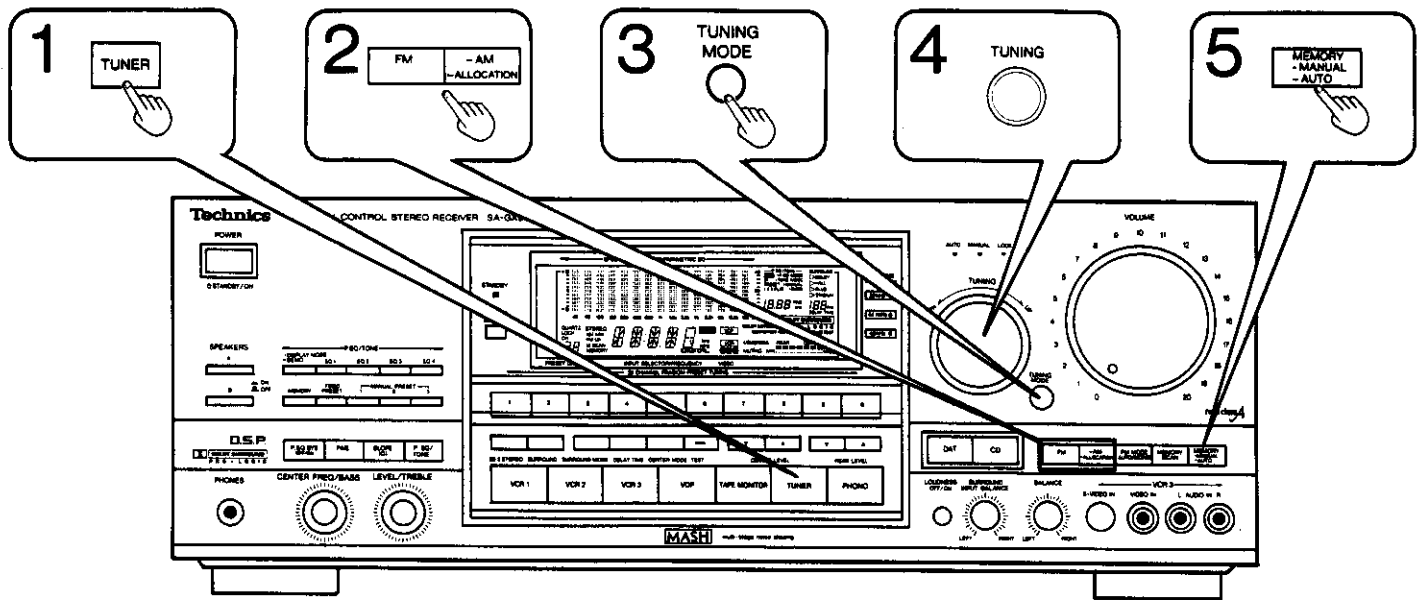

## Memory presettings (continued)

### Automatic memory presetting

Have you completed the steps (on page 18) of "Basic Operating Procedure" ?

When this method is used, the frequencies of the selected broadcast stations are automatically preset (in sequence from lower to higher frequencies) into memory: "channels" 1 to 30 are available for the presetting of FM stations, and "channels" 21 to 30 are available for AM stations.

When a presetting is made to a channel that has already been preset, the prior presetting will be erased, so if, for example, FM frequencies are preset to channel 1 to 30 and then AM frequencies are preset, the first AM frequency will be preset to channel 21 (thus erasing the FM presetting to channel 21), the second AM frequency will be preset to 22 (erasing FM 22), and so on.

- 1 Press the "TUNER" button.
- 2 Press the "FM" or "AM" button.  
Before presetting AM broadcast stations, press to select the appropriate frequency step for your locality.  
(Refer to item 57 on page 13.)
- 3 Select the desired tuning mode, "AUTO" or "MANUAL".

- 4 Turn the tuning control so as to set to the frequency from which you want to start automatic memory presetting.

In "AUTO" mode, the next station, higher or lower in broadcast frequency, will be automatically tuned in.

In "MANUAL" mode, the frequency will change, using the smallest step available, only as the tuning control is being turned. This will allow you to tune in all of the broadcast frequencies available in that band.

- 5 Press the memory button until the frequency begins to change.  
(Automatic memory presetting will start.)

For automatic presetting in areas where there are fewer than 30 stations for FM broadcasts, the remaining channels will be left unused. The unused channels can be filled by following steps 2 through 6 (on page 21.)

### Back-up memory

The back-up function maintains the preset memory and the most-recent memory (see below) when the power is switched OFF, in the event of a power failure, or if the power cord is disconnected. The memory will be maintained for as long as approximately one month.

#### Most-recent memory

The most-recent memory system "remembers" the broadcast station last tuned to when the unit was switched OFF. That station will be automatically tuned to when the power is switched ON.

#### If frequency presettings are accidentally erased

1. Switch ON the power switch for an hour or longer.
2. Repeat the frequency presettings procedure once again.

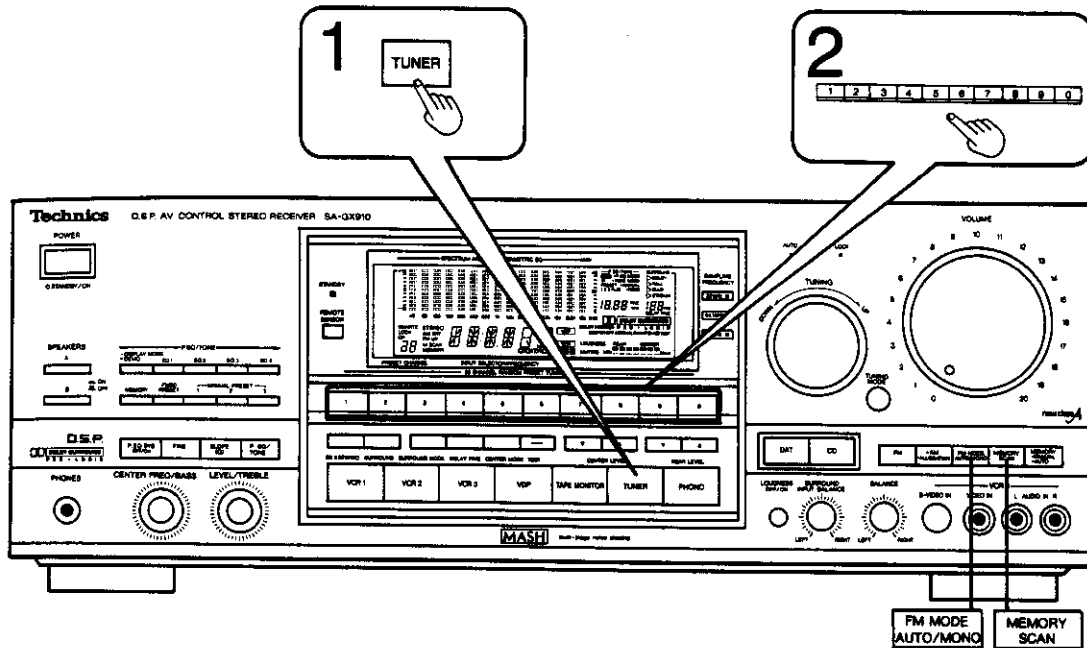

## Memory tuner operation (to listen to broadcast stations preset into memory)

Have you completed the steps on page 18 of "Basic Operating Procedure" and on pages 21~22 of "Memory presettings" ?

**1** Press the "TUNER" button.

**2** Select the desired "CHANNEL".

**To designate channels 1-9:**

Press the appropriate (1-9) preset-tuning button.

**To designate channels 10-30:**

- ① Press the button for the most significant digit (1, 2 or 3).
- ② Press the button for the least significant digit (1-0) within 2 seconds after pressing the first button.

If the interval between pressing the first button and pressing the second button is more than about 2 seconds, the setting may not be made correctly. If this happens, repeat the setting procedure once again.

**Station Memory File (Use this file to record your memory selections.)**

ch. 1	ch. 2	ch. 3	ch. 4	ch. 5	ch. 6	ch. 7	ch. 8	ch. 9	ch. 10	ch. 11	ch. 12	ch. 13	ch. 14	ch. 15
ch. 16	ch. 17	ch. 18	ch. 19	ch. 20	ch. 21	ch. 22	ch. 23	ch. 24	ch. 25	ch. 26	ch. 27	ch. 28	ch. 29	ch. 30

## Channel selection using the memory scan button

This feature is convenient for use when trying to locate a certain broadcast, or to listen to each station briefly to hear what is being broadcast.

**Press the memory scan button.**

Each frequency will then be heard (in sequence) for about 3 seconds.

The preset channel number will be displayed in the channel display.



Preset channel number



**When a broadcast you want to listen to is found**

**Press the memory scan button**

(The broadcast will continue, even after 3 seconds have passed.)



## If noise is excessive in the FM mode

**Press the FM mode selector.**



The sound will then be heard in monaural and the FM stereo indicator will not illuminate. If the broadcast signal is weak, or if there is a large amount of interference, sounds can be heard more clearly.

# Concerning the Parametric EQ System

There are two methods for adjusting the frequency response of this system: the parametric EQ and the tone control; Select whichever method you prefer.

## Parametric EQ

---

Conventional Graphic Equalizer only allow you to adjust the level of certain fixed frequency "bands". Additionally, adjusting one frequency "band" may also affect the level of adjacent frequency "bands".

The Parametric Equalizer, on the other hand, gives you four selectable frequency bands with a choice of 27 different frequencies from 40 Hz to 16 kHz. Also, the band width can be set "wide" or "narrow" for each selected center frequency.

This will determine how adjacent frequencies are affected by level adjustments in each band.

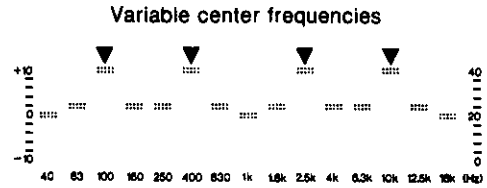

**Example:** Four bands of 10 dB boost

## Tone control

---

After changing this unit to the tone mode, use the bass control or treble control to adjust the balance of high-frequency and low-frequency sounds.



**Example:** In case the high-frequency range and the low-frequency range are boosted.



# Using the Parametric EQ

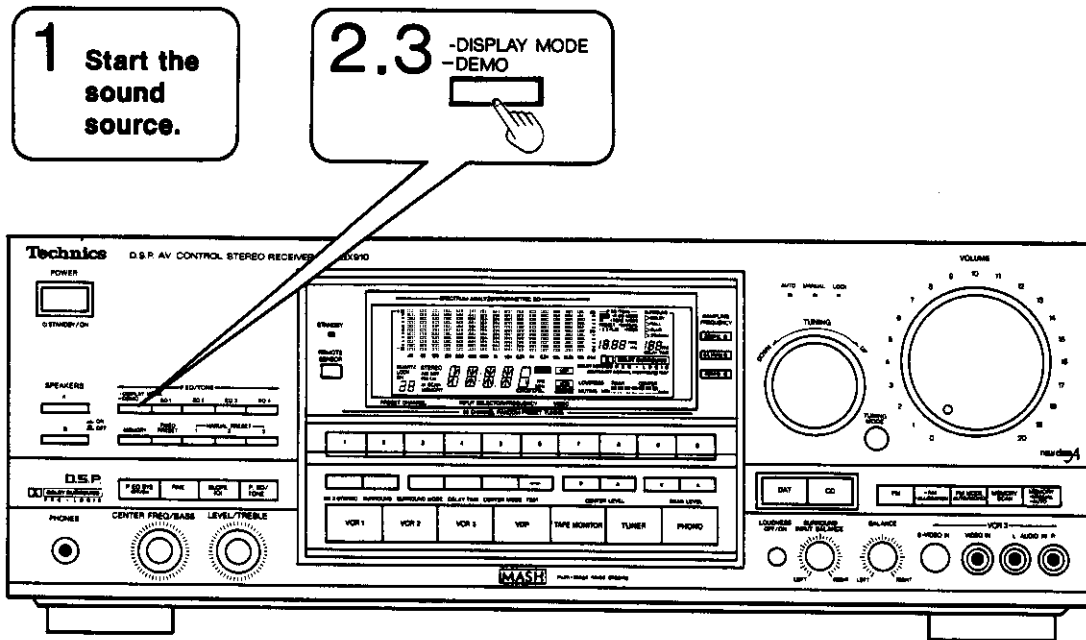

## Demonstration mode

In order to make the parametric EQ system easy to use, this unit comes with a factory programmed demonstration mode (adjustment example).

Refer to the demonstration as you carry out the operations on the following page, if necessary.

## Operation

**1 Start the sound source.**

**2 Press and hold the display mode select button for 3 seconds or more.**

The demonstration mode will start.  
Sound will be changed according to the change of display.  
The demonstration mode is automatically repeated.

**3 Press the display mode select button momentarily.**

The demonstration mode is cancelled and the display switches to the original display mode.  
The preferred display mode can now be selected.

# Using the Parametric EQ (continued)

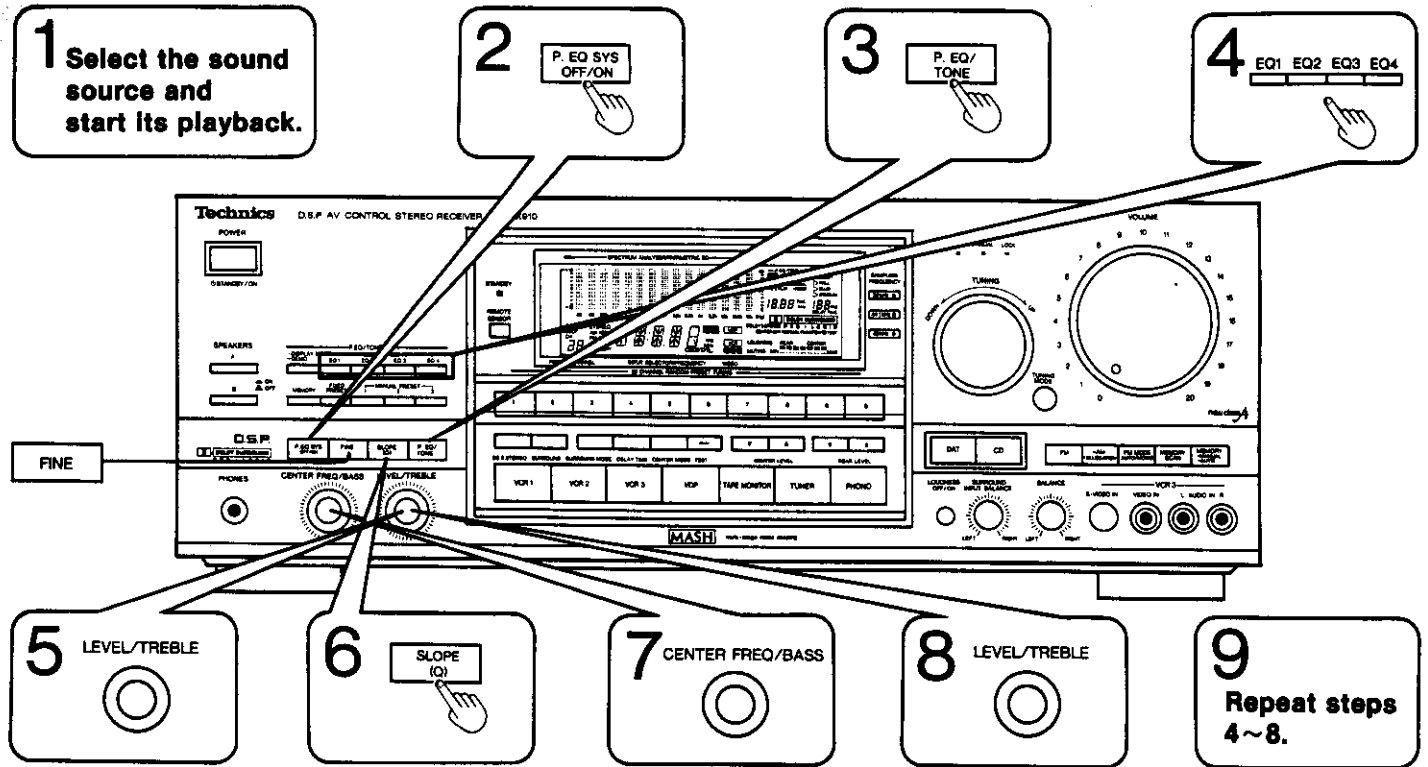

## Adjustment of the parametric EQ

1 Select the sound source and start its playback at a moderate volume level.

4 Select the band to be adjusted.  
(The center frequency level and band indication to be adjusted will flash for about 5 seconds.)

2 Turn on the parametric EQ system.  
(The parametric EQ system off indicator goes out.)

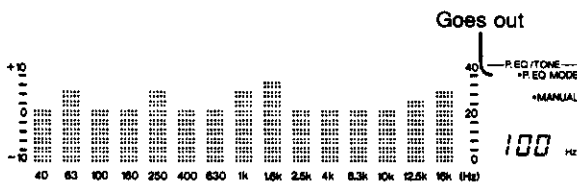

EQ1: 40 Hz ~ 400 Hz to be adjusted

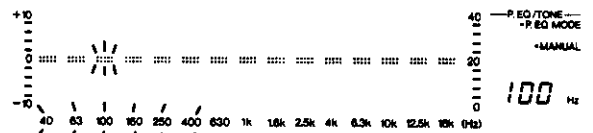

EQ2: 160 Hz ~ 1 kHz to be adjusted

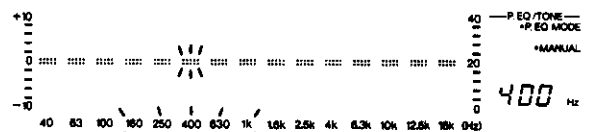

3 Select the parametric EQ mode.  
(The parametric EQ mode indicator will illuminate.)

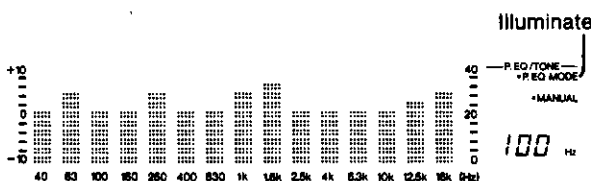

EQ3: 630 Hz ~ 6.3 kHz to be adjusted



EQ4: 4 kHz ~ 16 kHz to be adjusted

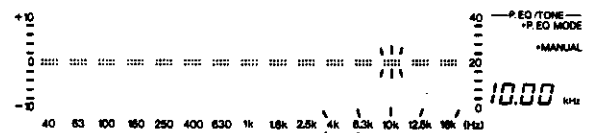

**5 Set the center frequency level (flashing bar) to +10 dB.**

The illustration shown below is an example for EQ1.

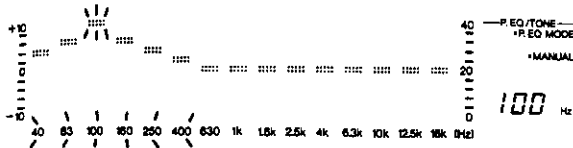

**6 Select the preferred slope, "narrow" or "wide".**

The curve slope selection changes from "narrow" to "wide" each time this button is pressed.

The illustration shown below is an example for EQ1.

When "narrow" is selected:

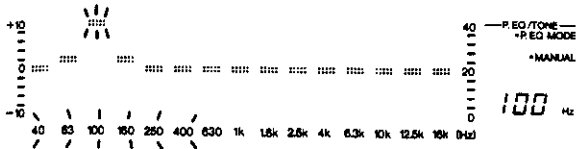

When "wide" is selected:

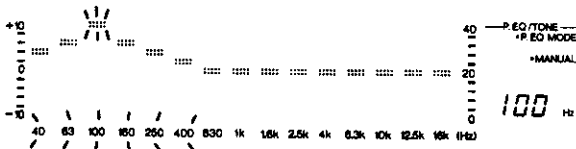

**7 While listening to the sound source, select the desired center frequency.**

See the "characteristics of center frequency" section below to help you determine the desired center frequency. To select the center frequency more precisely, see "Fine adjustment of the center frequency" below.

**8 While listening to the sound source, readjust the level as required.**

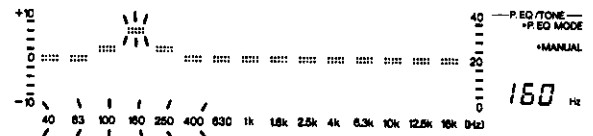

**9 Repeat steps 4-8 to adjust the center frequency in the remaining bands.**

**Caution:**

Extreme level adjustments in any frequency band may cause damage to your receiver and/or your speakers.

**Fine adjustment of the center frequency**

In step 7 above, press the fine mode select button to select the desired center frequency while watching the parametric EQ system center frequency display.

(The fine mode indicator will illuminate and you will notice that the frequency spectrum now has more resolution.)

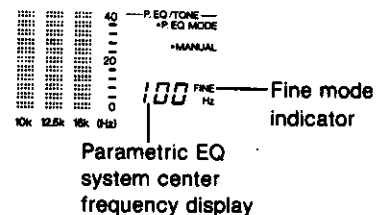

**Characteristics of center frequency**

**40 Hz ~ 63 Hz**

This is the deep bass sound range. When this level is increased, the sound quality of a bass guitar, drums, etc. will be stabilized for a full, rich sound.

**100 Hz ~ 160 Hz**

This is the bass sound range. When this level is increased, the sound will seem to have a greater fullness and depth. Indistinct sounds can, moreover, be made distinct by lowering the level.

**250 Hz ~ 400 Hz**

This range is the fundamental sound range. When this level is increased, a forceful "punch" is added. This level adjustment is also used to add additional richness to male vocal sounds.

**630 Hz ~ 1 kHz**

This is the range in which most of the vocal range of the human voice is included. By increasing the control setting, vocal reproductions become more full of life, and greater realism and ambience can be added.

**1.6 kHz ~ 2.5 kHz**

String instruments and wind instruments are in this range. When this level is increased, their brilliance is emphasized for more colorful sound.

**4 kHz ~ 6.3 kHz**

This is the range for adjusting sound's luster and brightness. When this level is increased, an additional degree of brilliance and color is added. For sounds which seem too metallic, on the other hand, they can be softened by reducing the level.

**10 kHz ~ 16 kHz**

This is the range in which finely subtle tones of radiance and splendidous luminance can be added. By increasing the control setting, an extra measure of glitter can be added, for example, to the sounds of the cymbals, triangle, etc. This control can also be used, by reducing its setting, to decrease annoying tape "hiss" noises.

# Using the Parametric EQ (continued)

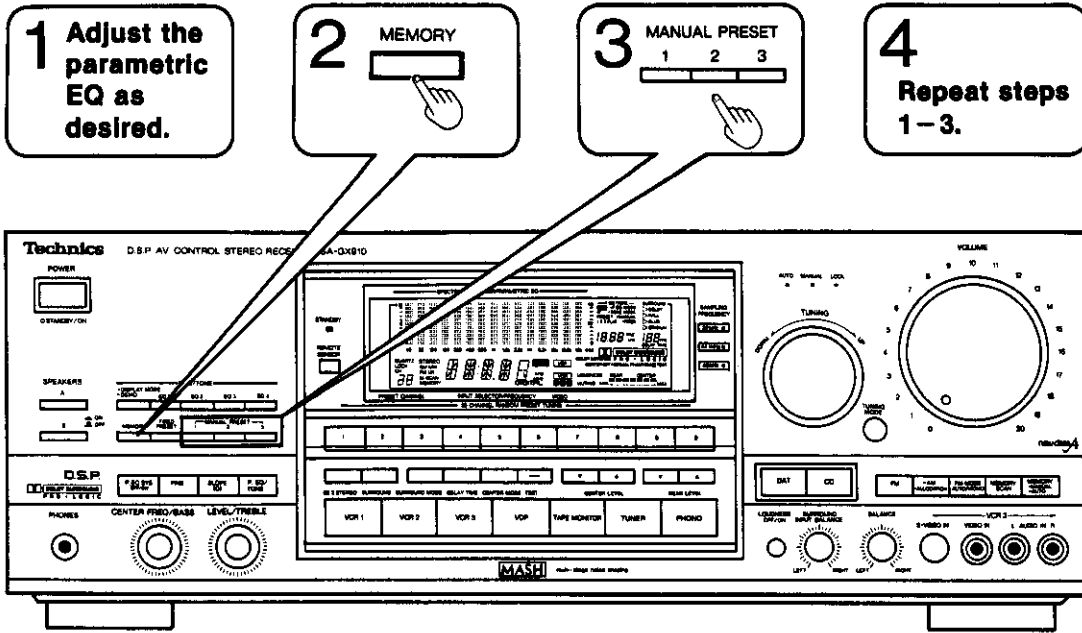

## Storing a curve in memory

Up to three curve presets can be stored in this unit's memory.

- 1 Adjust the parametric EQ as desired.**  
(Refer to pages 26-27.)
- 2 Press the parametric EQ system memory button.**  
(The parametric EQ system memory indicator illuminates.)

- 3 Select the channel of your choice.**  
(The selected channel illuminates.)

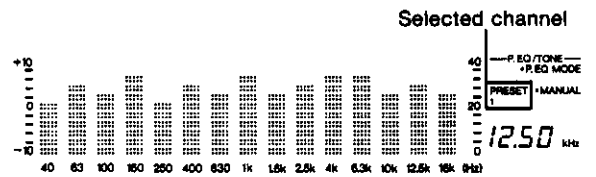
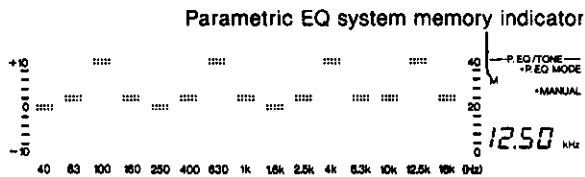

- 4 Repeat steps 1-3.**

## To recall a curve from memory

- Use the equalizer preset button to select the channel of your choice.**  
(The selected channel illuminates and the stored curve will be displayed for about 2 seconds.)

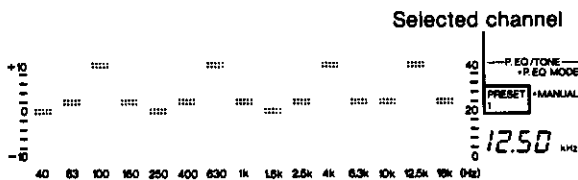
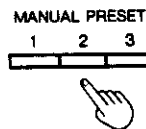

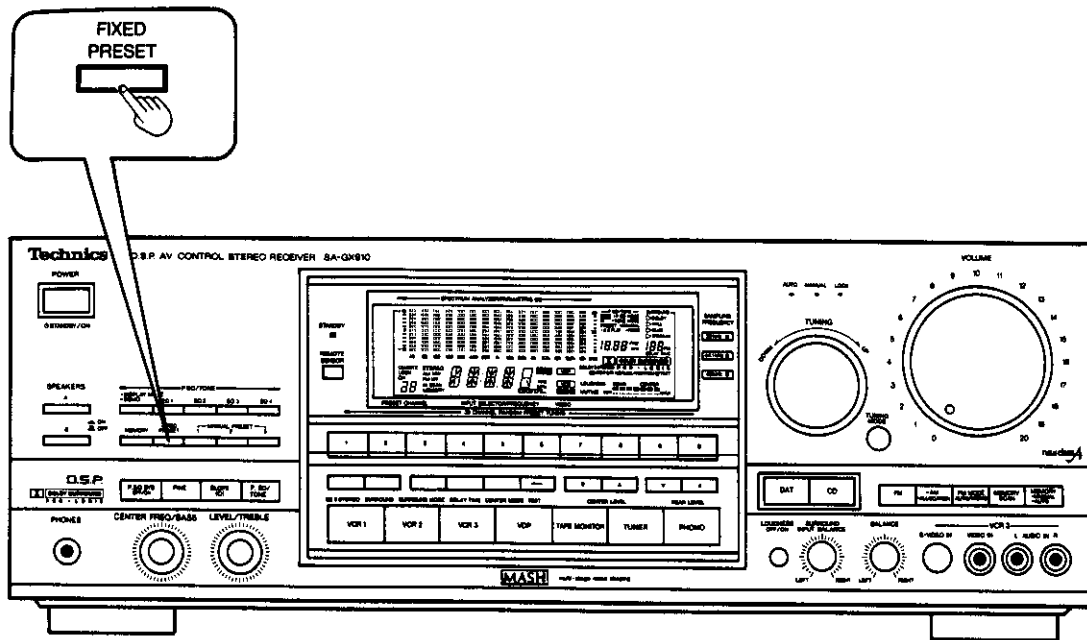

## To recall factory pre-programmed curves

Four factory pre-programmed curves are conveniently arranged in this unit's memory. These are: PRESET 1 (heavy), PRESET 2 (vocal), PRESET 3 (soft) and FLAT. Select the one of your choice.

**Press the fixed preset button.**

Each time the button is pressed, the fixed preset indicators illuminate and the display changes as shown below.



### PRESET 1 (heavy)

This curve can be used to add "punch" to rock and other music.

### PRESET 2 (vocal)

This curve can be used to clarify vocals.

Fixed preset indicators

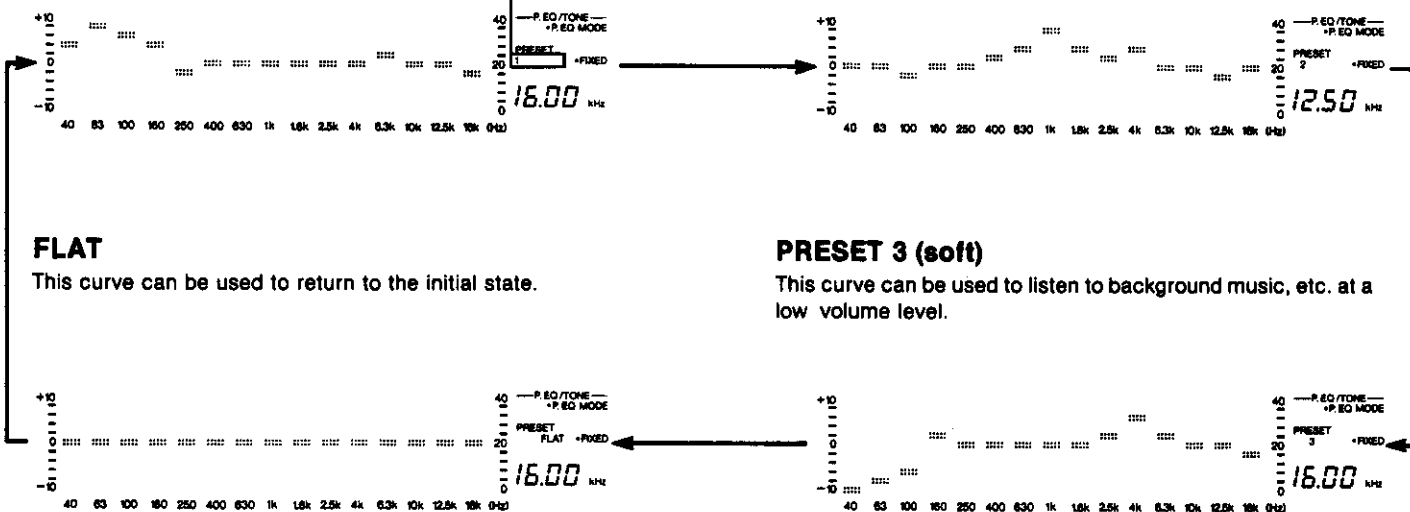

### FLAT

This curve can be used to return to the initial state.

### PRESET 3 (soft)

This curve can be used to listen to background music, etc. at a low volume level.

# Using the Tone Control

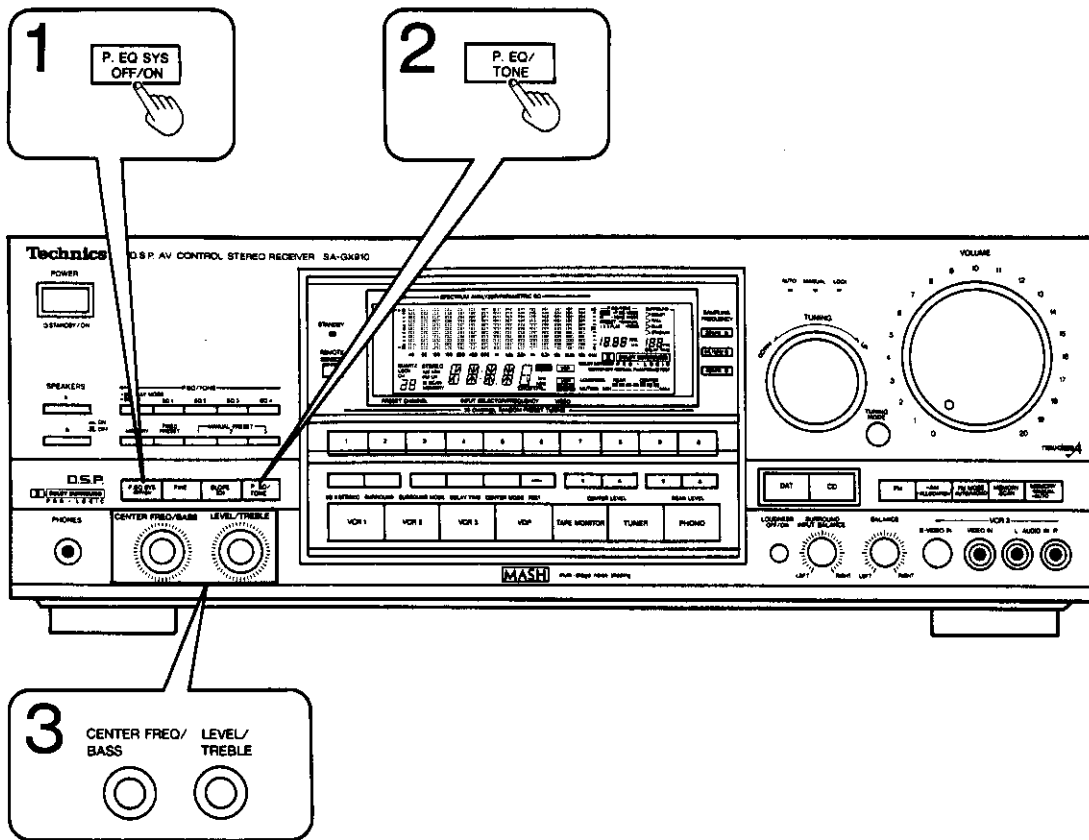

## Adjustment of tone control

- 1 Turn on the parametric EQ system.  
(The parametric EQ system off indicator goes out.)

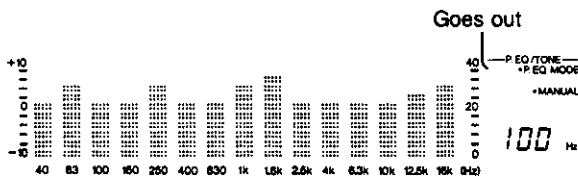

- 3 Adjust the tone balance.

Adjust the low-frequency sound to the desired level.

CENTER FREQ./BASS



Adjust the high-frequency sound to the desired level.

LEVEL/TREBLE



- 2 Press the parametric EQ/tone mode select button to select the tone mode.  
(The tone mode indicator will illuminate.)

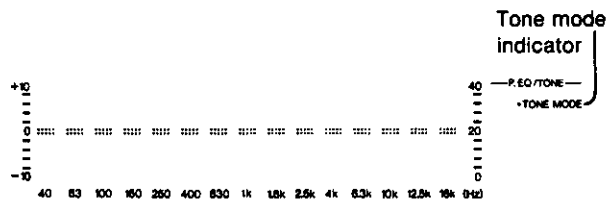

Note that these controls can be rotated beyond their positive (+) or negative (-) extremes.

However, when either extreme is reached, the controls have no effect.

### Caution:

Extreme level adjustments in either frequency band may cause damage to your receiver and/or speakers.

# Concerning Sound Mode Operation

There are two modes available for this unit.  
Select the one of your choice.

## Surround-sound mode

The surround-sound system functions impart presence and spread and thereby enhance and enrich the music.  
There are four surround-sound modes available for this unit.  
Select the one of your choice.

### **DOLBY (Dolby Pro-Logic):**

Uses a circuit that was developed for sound and video recording used in cinemas. This is the most appropriate mode for playback of tracks encoded with Dolby surround.

### **HALL:**

From classical to pop, to rock, this function imparts a deep bass and spread which will make you feel as if you are in a large concert hall.

In order to enjoy the maximum benefit of these functions, we recommend you install rear speakers (not included) and a center speaker (not included).  
The center speaker only works with the Dolby Pro-Logic Surround.

### **CLUB:**

Primarily for vocal pieces, this function adds gloss to the vocals and you'll feel as though you were hearing a live stage performance.

### **STADIUM:**

When listening to baseball or football relay broadcasts, this function automatically sets the appropriate bass level for the announcer's voice (mono) and audience cheers (stereo). It is also effective for sources with the DJ's voice mixed in with the music.

## Dolby 3 stereo mode

When playing back with this mode, the front signals become clear and sharp, without any "sound hole" effects that 2-channel reproduction may cause. If the speakers are placed on both sides of the TV, regardless of the distance between the speakers or a place in which you watch and listen, the optimum stereo effects and channel separation will be realized.

## Positioning the speakers

The illustration at the right is an example when enjoying Dolby Pro-Logic Surround-sound.  
When enjoying Dolby 3 stereo sound, the rear speaker is not necessary.

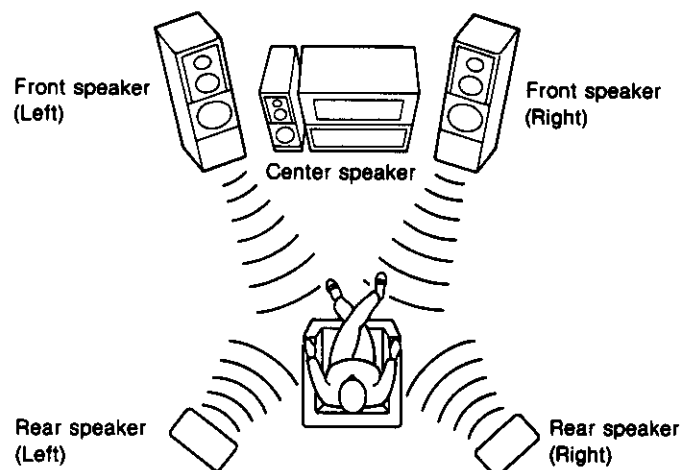

# Using the Dolby Pro-Logic Surround

The Dolby Pro-Logic Surround System recreates, in your home, the powerful and dynamic sound space of a movie theater, when used with Dolby Pro-Logic encoded source materials.

Manufactured under license from Dolby Laboratories Licensing Corporation. Additionally licenced under one or more of the following patents: U.S. numbers 3,632,886, 3,746,792 and 3,959,590; Canadian numbers 1,004,603 and 1,037,877. "Dolby" and the double-D symbol are trademarks of Dolby Laboratories Licensing Corporation.

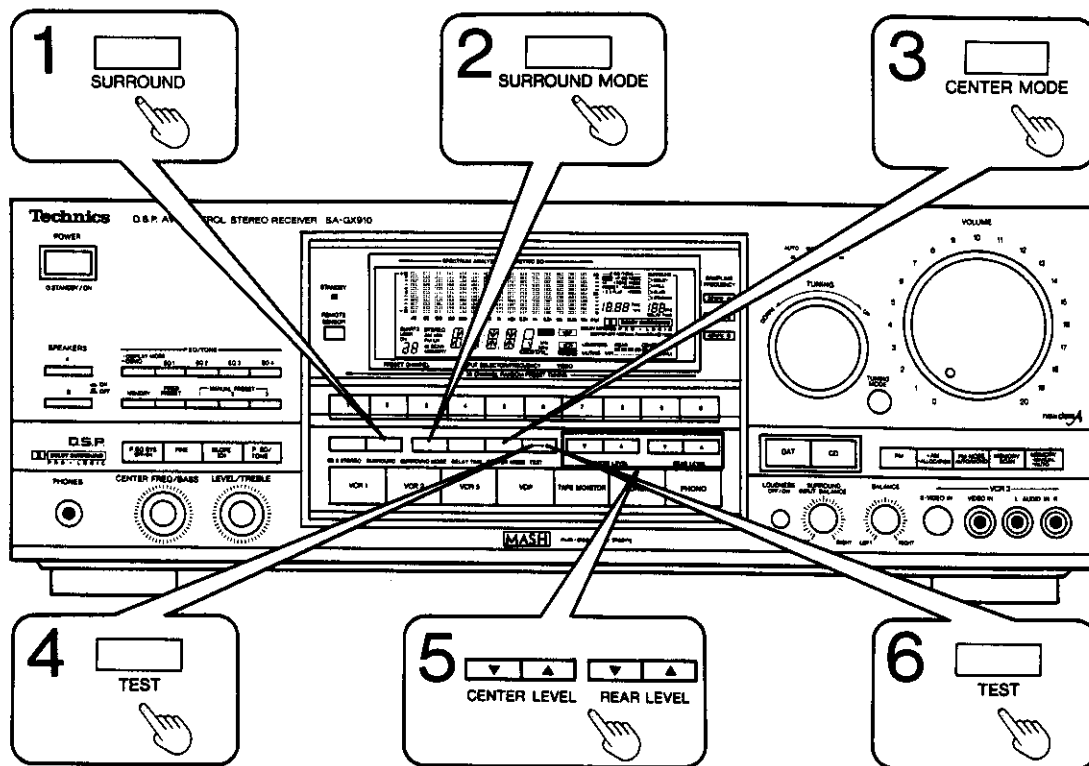

## Adjustment of each channel balance

- 1 Turn on the surround-sound system.  
The (▶) mark will be displayed in the surround mode display.

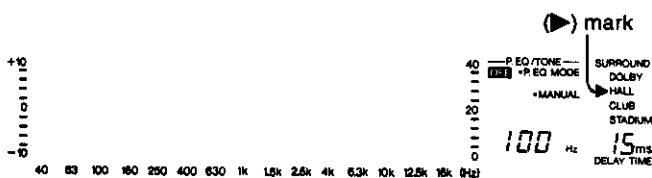

- 3 Select one of the center modes.  
Each time the button is pressed, the center mode indicators will change as follows: NORMAL→PHANTOM→CENTER OFF...  
NORMAL .....Select this mode when using the center speaker and the rear speakers.  
PHANTOM .....Select this mode when not using the center speaker (In this case, the center speaker channel is played through the left and right speakers).  
CENTER OFF .....Select this mode when adjusting the INPUT BALANCE. (See page 34.)

- 2 Select the "DOLBY" mode.  
Each time the button is pressed, the (▶) mark will change as follows: DOLBY→HALL→CLUB→STADIUM...  
The Dolby Pro-Logic Surround indicator illuminates simultaneously when this mode is selected.

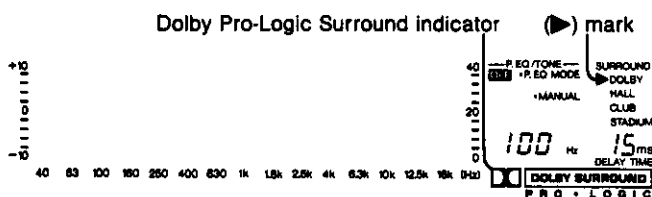

- 4 Press the test signal transmission button.  
Test signal sounds sequentially as follows:  
Front speaker (left) → Center speaker  
↑ ↓  
Rear speakers (left, right) ← Front speaker (right)
- 5 Adjust the volume balance.  
While standing in the listening area, adjust the output level of each speaker until they are all identical.  
▼: Decrease the output level.  
▲: Increase the output level.
- 6 Stop the test signal.



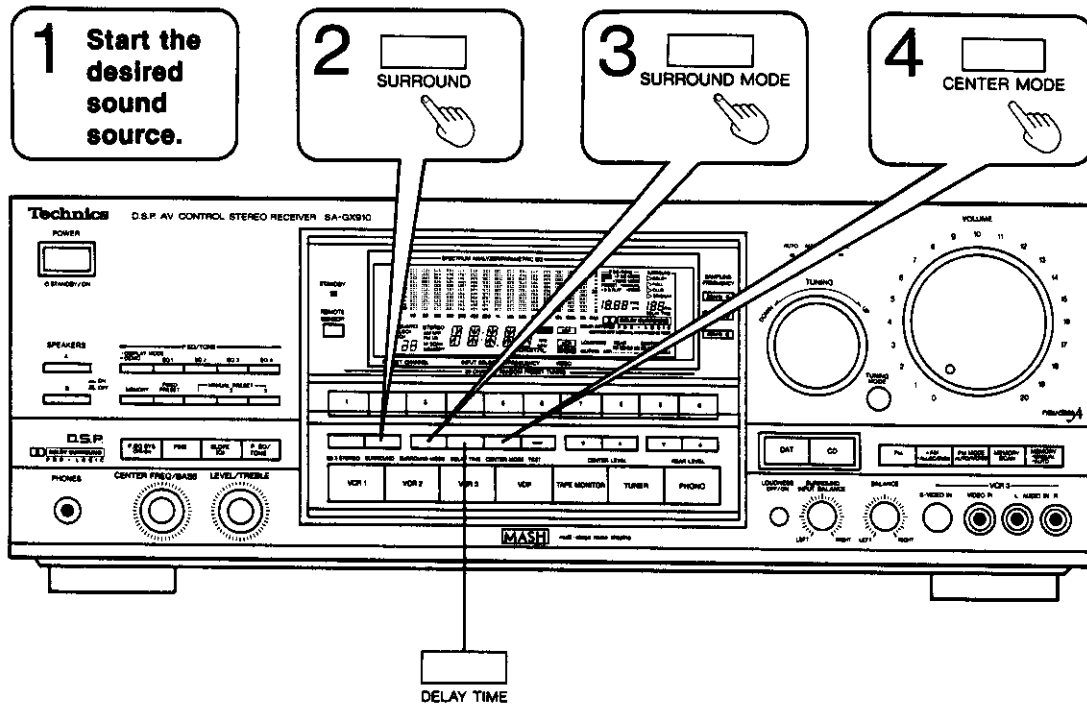

## Enjoying Dolby Pro-Logic Surround-sound

- 1 Start the desired sound source.
- 2 Turn on the surround-sound system.
- 3 Select the "DOLBY" mode.

Each time the button is pressed, the (▶) mark will change as follows: DOLBY → HALL → CLUB → STADIUM...  
The Dolby Pro-Logic Surround indicator illuminates simultaneously when this mode is selected.

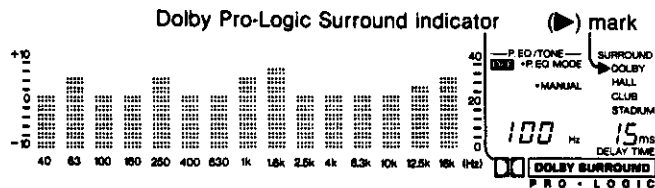

- 4 Select one of the center modes.

Each time the button is pressed, the center mode indicators will change as follows: NORMAL → PHANTOM → CENTER OFF...

NORMAL ..... Select this mode when using the center speaker and the rear speakers.

PHANTOM ..... Select this mode when not using the center speaker (In this case, the center speaker channel is played through the left and right speakers).

CENTER OFF ..... Select this mode when adjusting the INPUT BALANCE. (See page 34.)

## To adjust the delay time

Adjust the delay time while listening with the Dolby Pro-Logic Surround function on.

Each time the button is pressed, the delay time will change as follows: 15 ms → 20 ms → 25 ms → 30 ms



Adjustment is made depending on where the rear speakers are set. If the speakers are placed far from the point of listening, adjust the delay time to short, and if placed near, adjust to long.

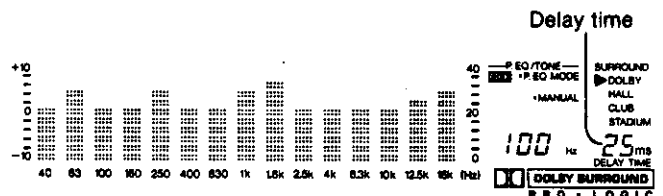

# Using the Dolby Pro-Logic Surround

(continued)

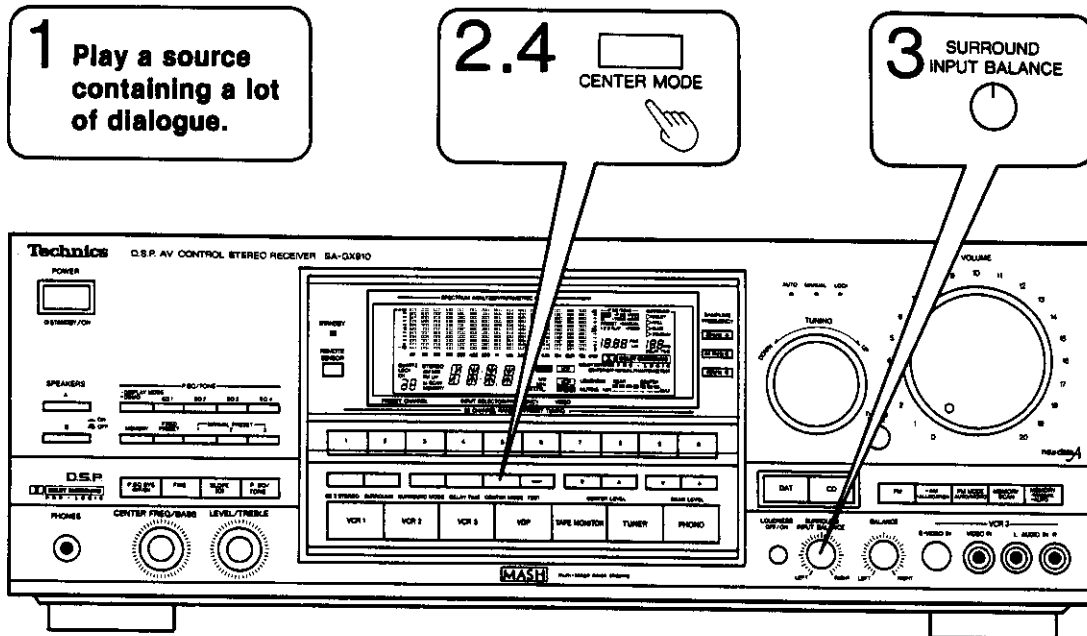

## To adjust the input balance

Conversation sounds are usually heard only from the center speaker, but depending on the quality of the software being used (video tape, video disc, etc.), occasionally conversation sounds may be heard from the front speakers. If this occurs, while listening to the selection adjust the input balance control to reduce the conversation sounds as much as possible.

**1 Play a source containing a lot of dialogue.**

**3 Adjust the Dolby surround input balance control, until the dialogue is barely audible.**

**2 Select the "CENTER OFF" mode.**

Each time the button is pressed, the center mode indicators will change as follows: NORMAL→PHANTOM→CENTER OFF...

**4 Return the center mode select button to "NORMAL" or "PHANTOM".**

# Using the Other Surround-Sound (HALL, CLUB, STADIUM)

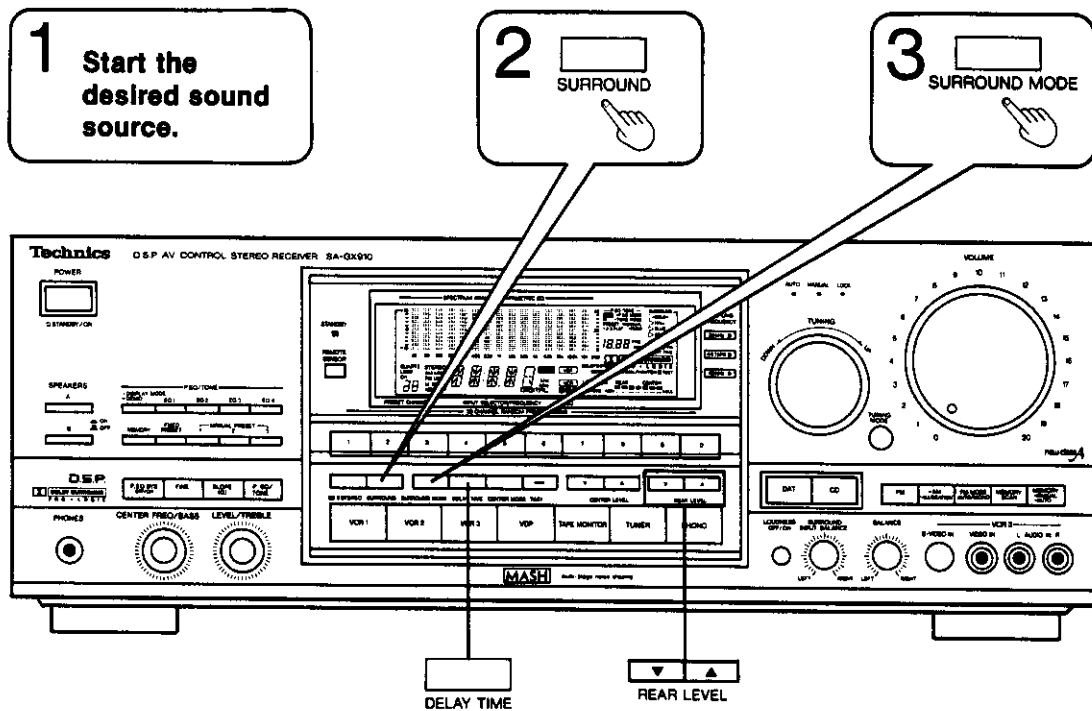

## Enjoying the other surround-sound (HALL, CLUB, STADIUM)

1 Start the desired sound source.

2 Turn on the surround-sound system.

3 Select the desired surround-sound mode.

Each time the button is pressed, the (▶) mark will change as follows: **DOLBY**→**HALL**→**CLUB**→**STADIUM**

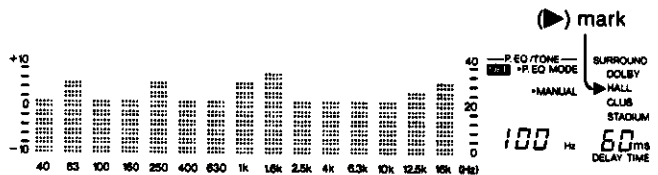

## To adjust the volume level of the rear speakers

Press one of the rear speaker level adjustment button to adjust the volume level.



## To adjust the delay time

Press the delay time adjustment button.

Each time the button is pressed, the delay time will change as described at the right.



Mode	Possible ranges
HALL/ STADIUM	40 ms→60 ms→80 ms→100 ms→120 ms
CLUB	10 ms→15 ms→20 ms→25 ms→30 ms

# Using the Dolby 3 Stereo System

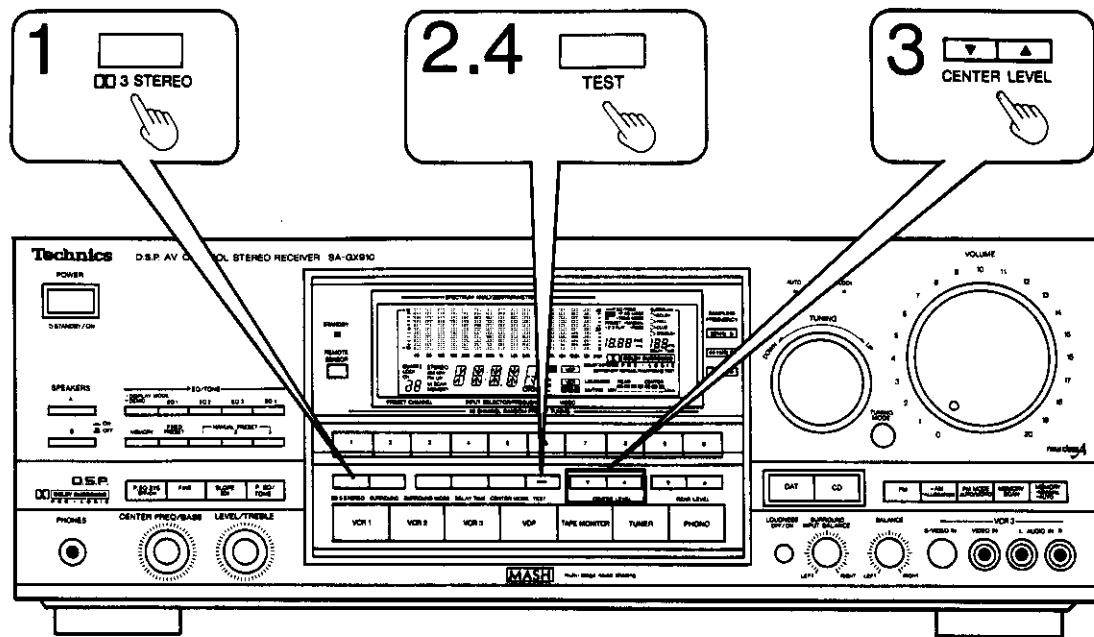

## Adjustment of each channel balance

**1** Turn on the Dolby 3 stereo system.

**2** Press the test signal transmission button.

Test signal sounds sequentially as follows:

Front speaker (left) → Center speaker

↑

Front speaker (right) ←

**3** Adjust the volume balance.

While standing in the listening area, adjust the output level of each speaker until they are all identical.

▼: Decrease the output level.

▲: Increase the output level.

**4** Stop the test signal.

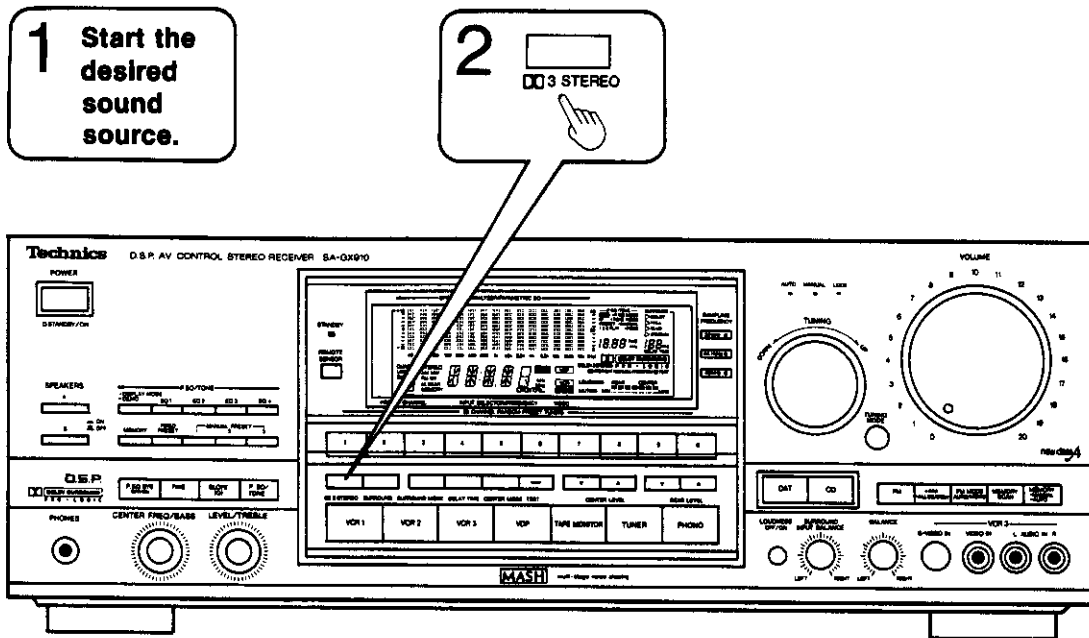

## Enjoying Dolby 3 stereo sound

- 1 Start the desired sound source.
- 2 Turn on the Dolby 3 stereo system.  
(The Dolby 3 stereo indicator will illuminate.)

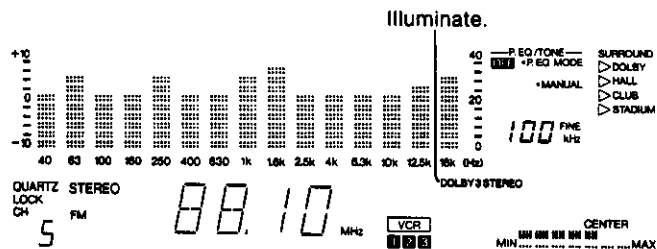

# While listening to music

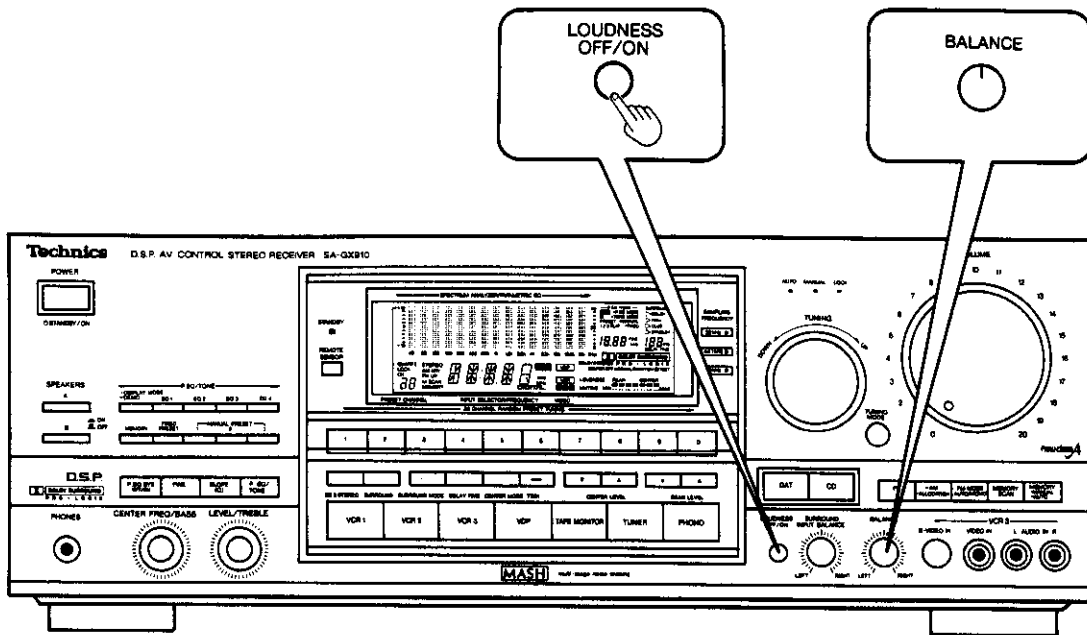

## To emphasize low-frequency sound

Set the loudness switch to "ON" position.

The loudness indicator will illuminate.

**Note:**

This feature is especially useful when listening to music at low volume levels, as it enhances the low frequency sounds that are usually lost.

LOUDNESS  
OFF/ON

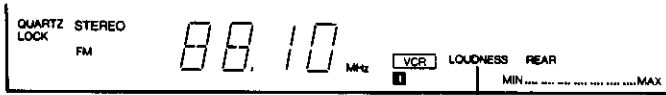

Loudness indicator

## To adjust the left/right sound balance

Adjust the balance control.

BALANCE



**Note:**

The left/right volume balance of the rear speaker systems cannot be adjusted.

# Recording

Have you completed the steps (on page 18) of "Basic Operating Procedure" ?

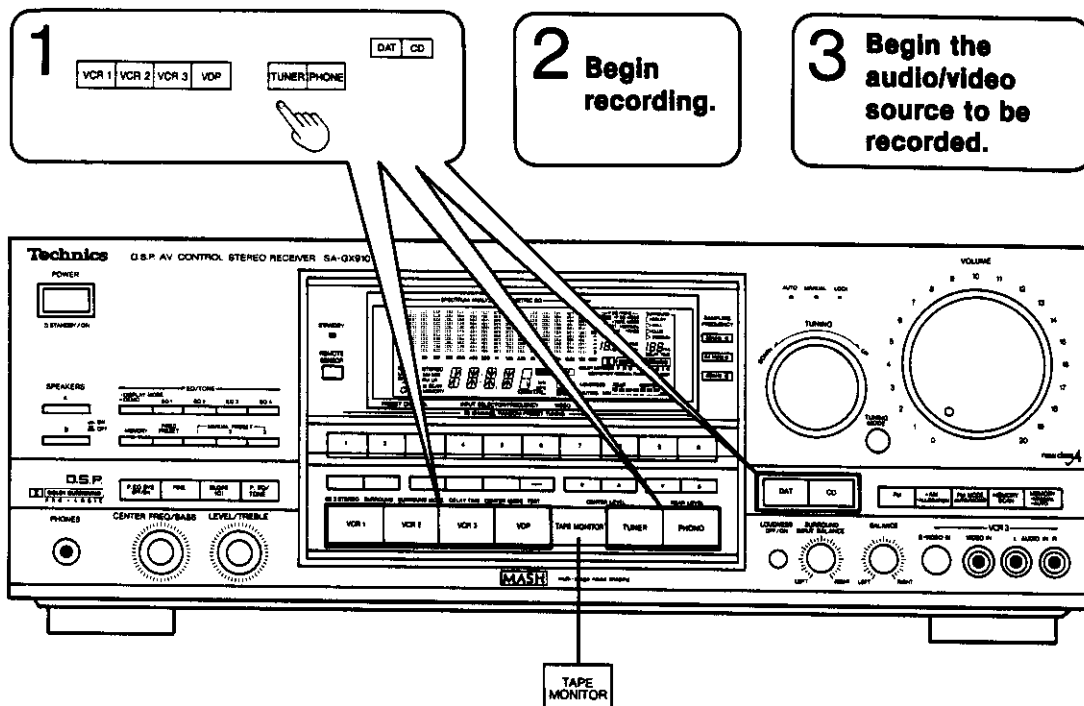

## Tape recording

To record on the tape deck and/or digital audio tape deck (DAT) connected to the "TAPE" and "DAT" terminals. Before recording, prepare the tape deck and/or DAT for recording (recording level adjustment, etc.).

**1 Select the audio/video source for recording.**

**2 Begin recording.**

Follow your tape deck's and/or DAT's operating instructions.

**3 Begin the audio/video source to be recorded.**

**Note:**

When proceeding the digital recording from "CD" to "DAT", follow the operating steps as shown above after the connecting the CD and/or DAT to the main unit with optical-fiber cables (refer to page 5).

## To listen to the sound being recorded to the tape deck

Press the tape-monitor switch (TAPE-MONITOR) while recording.

(The tape indicator will illuminate.)

Follow your tape deck's operating instructions for availability and operation of the tape monitor function.



## VCR (VCR 1 and/or VCR 2) recording

Before recording, prepare the VCR 1 (or VCR 2) for recording. Be sure to set the input selector on the VCR to the external input position.

**1 Select the video source for recording.**

Then, select the audio source if it is different from the video source as in simulcast broadcasting.

**2 Begin recording.**

Follow your VCR's operating instructions.

**3 Begin the audio/video source to be recorded.**

When recording the video disc on a video tape by using the S-video terminal, set the input mode switch of the VCR to S-video. (Refer to the operating instructions of the VCR for details.)

# Edit-Recording

Have you completed the steps (on page 18) of "Basic Operating Procedure" ?

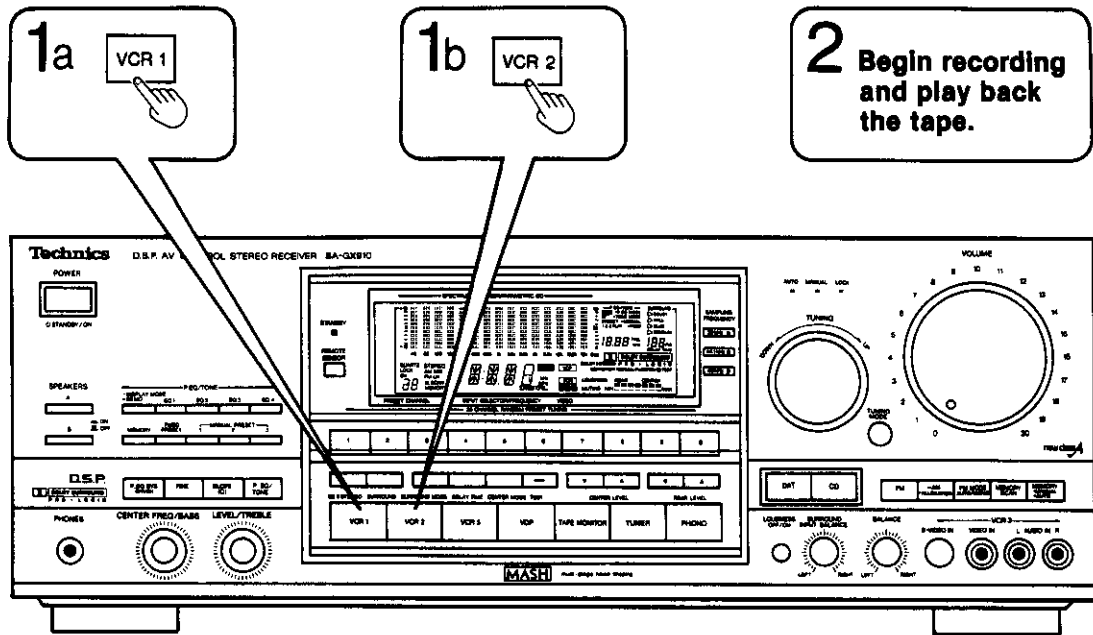

## Edit recording from VCR 1 to VCR 2 and vice versa —

Before recording, prepare the VCR (VCR 1 or VCR 2) for recording (recording level adjustment, etc.).

### 1a To record from the VCR 1 to the VCR 2:

Press the "VCR 1" button.

(The "1" will be displayed on the VCR display.)

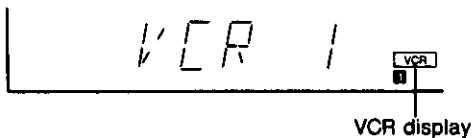

### 2 Begin recording on the VCR (VCR 1 or VCR 2) and play back the tape on the playback VCR (VCR 1 or VCR 2).

Follow your VCR's operating instructions.

### 1b To record from the VCR 2 to the VCR 1:

Press the "VCR 2" button.

(The "2" will be displayed on the VCR display.)





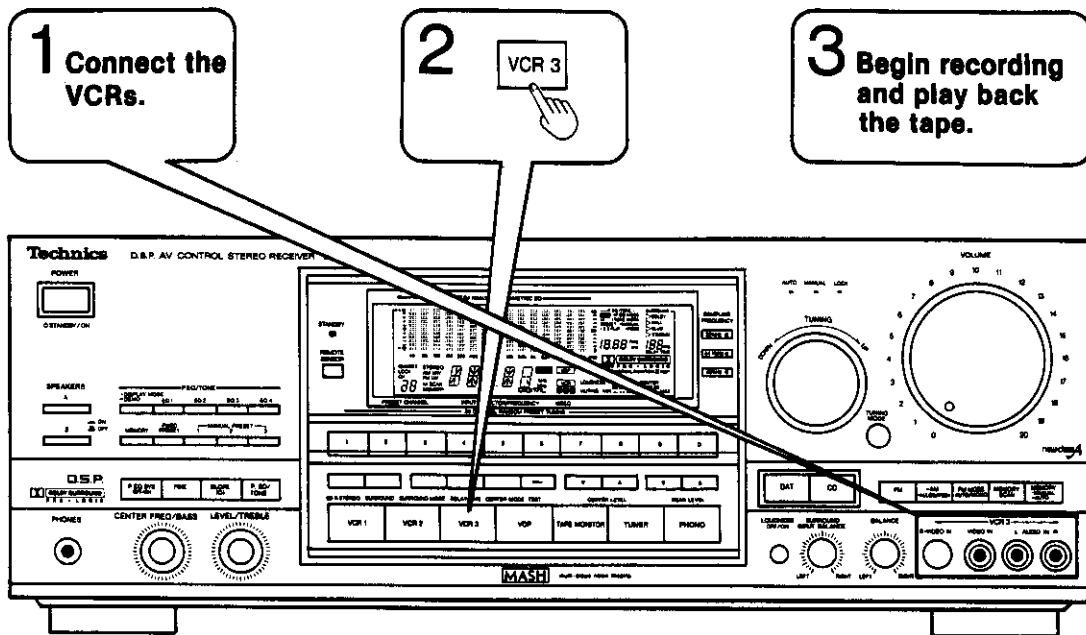

## Edit recording from VCR 3 to VCR 1 and/or VCR 2 —

With a VCR connected to the "VCR 1" and/or "VCR 2" terminals and a third VCR connected to the "VCR 3" terminal, edit-recording of video tapes is possible from VCR 3 to VCR 1 and/or VCR 2.

### 1 Connect the VCRs.

- "VCR 1" and/or "VCR 2" terminals.....To be used for recording (See page 7.)
- "VCR 3" terminal.....To be used for playback (See below.)

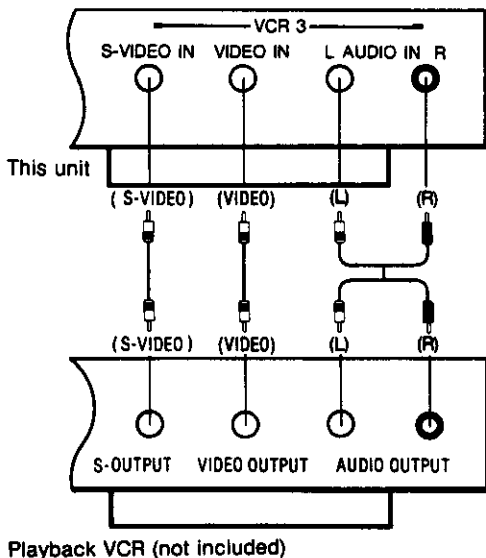

### 2 Press the "VCR 3" button.

(The "3" will be displayed on the VCR display.)

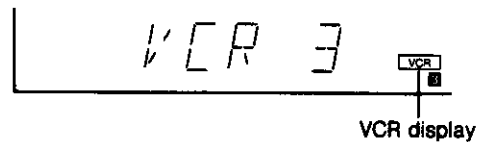

### 3 Begin recording on the VCR 1 and/or VCR 2 and play back the tape on the playback VCR (VCR 3).

Follow your VCR's operating instructions.

# Concerning the Remote Control

## Battery installation

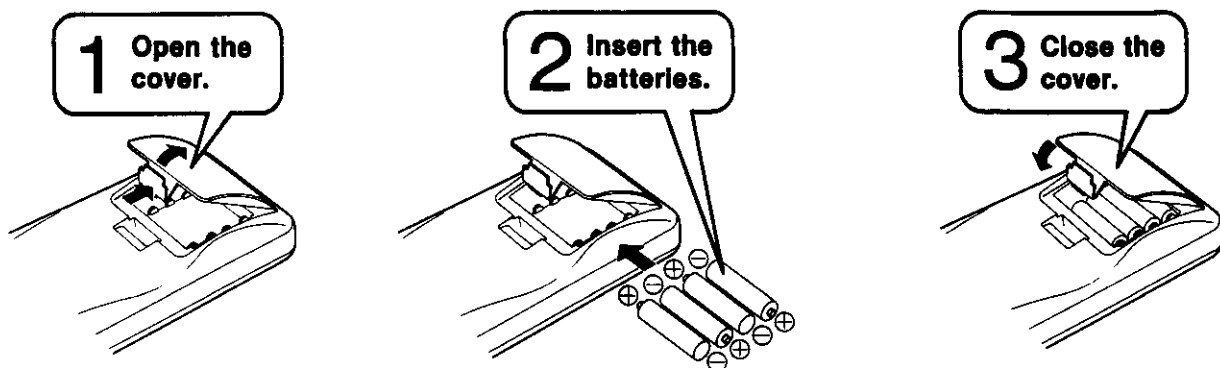

### 1 Open the cover.

Press the lever and move the cover in the direction of the arrow.

### 2 Insert the batteries.

Use four manganese batteries [R03 (UM-4) "AAA" 1.5 V].

Be sure that the batteries are inserted so that their positive (+) and negative (-) polarities match the polarities indicated in the compartment. Batteries installed incorrectly may leak and cause damage.

Refer to "Use of batteries" for additional information.

### 3 Close the cover.

## Use of batteries

Do not mix old and new batteries, or batteries of different types (carbon and manganese, etc.).

Always remove old, weak or worn-out batteries promptly and dispose of them properly.

The battery life is about 6 months.

Although the battery life varies depending on how often the device is used, the batteries should be replaced about once every 6 months on the average.

Because a fairly large power is required in order to enter other remote-control signals into the memory of this unit, note that the batteries will weaken faster if such memory entries are made often.

The batteries should be replaced if commands from the remote control transmitter do not operate the unit even when the transmitter is held close to the front panel or when the display becomes dim during operation.

Never subject batteries to excessive heat or flame; do not attempt to disassemble them; and be sure they are not short-circuited.

Since this unit retains the memory of the "learning" keys for about one hour from the time the batteries are removed, when replacement is necessary, be sure to have the new batteries ready at hand before removing the old batteries.

If the memorized codes are erased by not replacing the batteries quickly, reprogram this unit again. The original pre-programmed remote-control codes are not erased.

If a battery leaks, remove all batteries and dispose of them properly. Thoroughly clean the battery compartment before inserting new batteries.

If the electrolyte comes into contact with skin or clothes, flush with water immediately.

Keep batteries out of reach of children.

Do not use rechargeable (nickel-cadmium) type batteries.

## Operation notes

Aim the remote control's transmission window toward the unit's sensor. Avoid any obstacles.

When operating components other than compact disc player and cassette tape deck face the remote-control transmitter toward the remote-control signal receptor of each component.

Use the remote control within a 60 degree angle and within 6 meters (20 ft.) from the unit.

The audio control panel of the remote control may be covered by a clear plastic protective sheet. This sheet may be removed if desired.

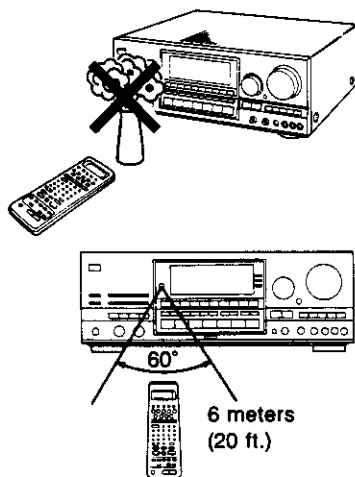

Be sure the transmission window and the unit's sensor are free from dust. Excessive dust might prevent reception.

The operation may not be correct if direct sunlight or another strong light source strikes the remote control signal sensor part of this unit. If there is a problem, place the unit away from the light source.

This remote control transmitter is pre-programmed with the remote control codes to enable operation of Panasonic AV units. However, if the range of the existing remote control transmitter is extremely short, if your AV unit is not manufactured by Panasonic, if it is manufactured by Panasonic but with different pre-programmed remote control codes, program the remote control codes from the remote control transmitter included with your AV unit into this remote control transmitter before operation. (See page 68 for details.)

# Remote-Control Operation (Audio)

For detailed information concerning operation steps, etc., please see the appropriate page of the operating instructions for each unit.

**1** Set the power of each component to ON.

Receiver

Compact disc player  
(not included)

Cassette tape deck  
(not included)

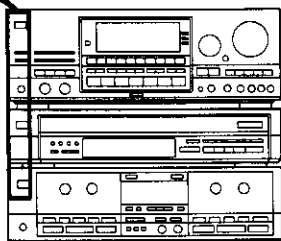

**2** AUDIO POWER

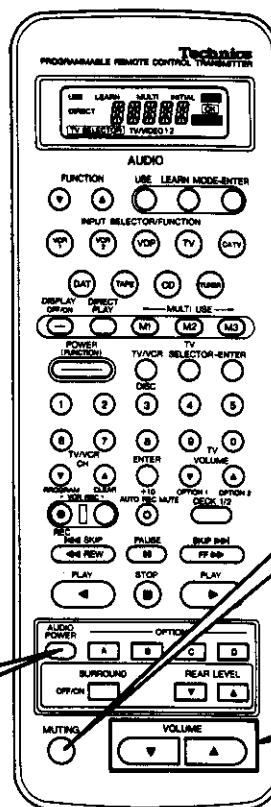

MUTING

VOLUME

## To switch each component's power ON/OFF

Have you connected the power cords as indicated on page 6?

**1** Set the power of each component to ON.

**2** Press the audio power key.

(The power of each component will be switched OFF.)  
The "STANDBY" indicator ("STANDBY") on the receiver will illuminate, and the indicators of all other components will switch OFF.

To restore power to all components, follow step 2 again.

## To attenuate the volume level

Press the muting key.

MUTING



The volume level is attenuated by approx., 20 dB (1/10).  
(The muting indicator on the receiver will illuminate.)

Press once again to resume to the previous volume level.  
(The muting indicator on the receiver will not illuminate.)

To resume to the previous volume level from the main unit, press and hold the "PHONO" input selector for about 5 seconds.  
(The unit will switch to the phono mode.)

## To adjust the volume level

Use the volume keys.

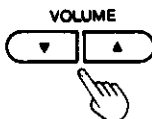

# Remote-Control Operation (Audio)

(continued)

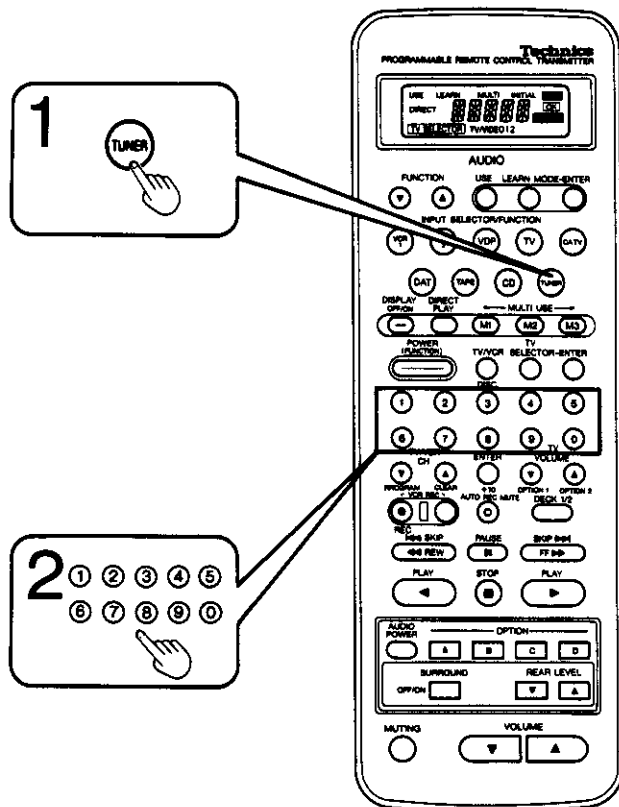

## Listening to radio broadcasts

Have you completed the steps (on pages 21 – 22) of “Memory presettings” ?

**1** Press the “TUNER” input/function select key.

**2** Select the desired “channel”.

**To designate channels 1 – 9:**

Press the appropriate (1 – 9) preset-tuning key.

**To designate channels 10 – 30:**

① Press the key for the most significant digit (1, 2 or 3).

② Press the key for the least significant digit (1 – 0) within 2 seconds after pressing the first key.

If the interval between pressing the first key and pressing the second key is more than about 2 seconds, the setting may not be made correctly. If this happens, make the setting once again.

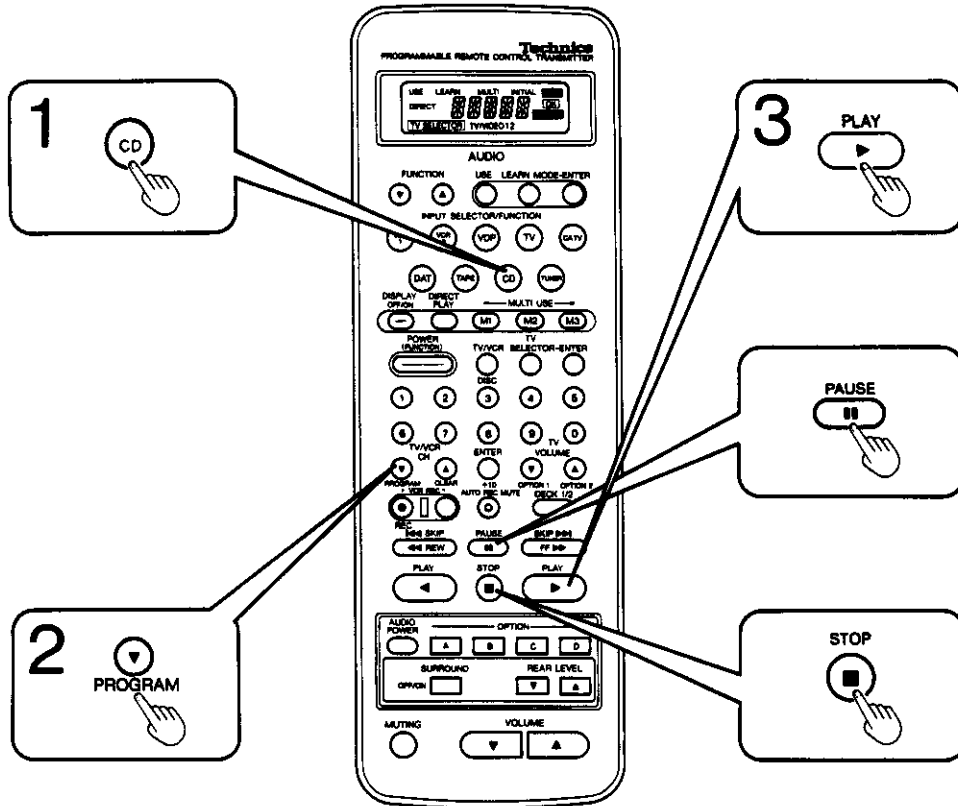

## Listening to compact discs

For a Technics compact disc player with the proper remote-control terminal or a remote-control sensor only.  
(Consult your dealer for details.)

### Sequential play

Sequential play refers to play of the first track of the first disc to the last track of the last disc.

1 Press the "CD" input/function select key.

2 Set the program/continue key to the continuous mode.

(The program indicator of the compact disc player will not illuminate.)

3 Press the play key.  
(Play will start.)

### To stop play temporarily

Press the pause key.

Press the play key to resume play.



### To stop play

Press the stop key.



# Remote-Control Operation (Audio)

(continued)

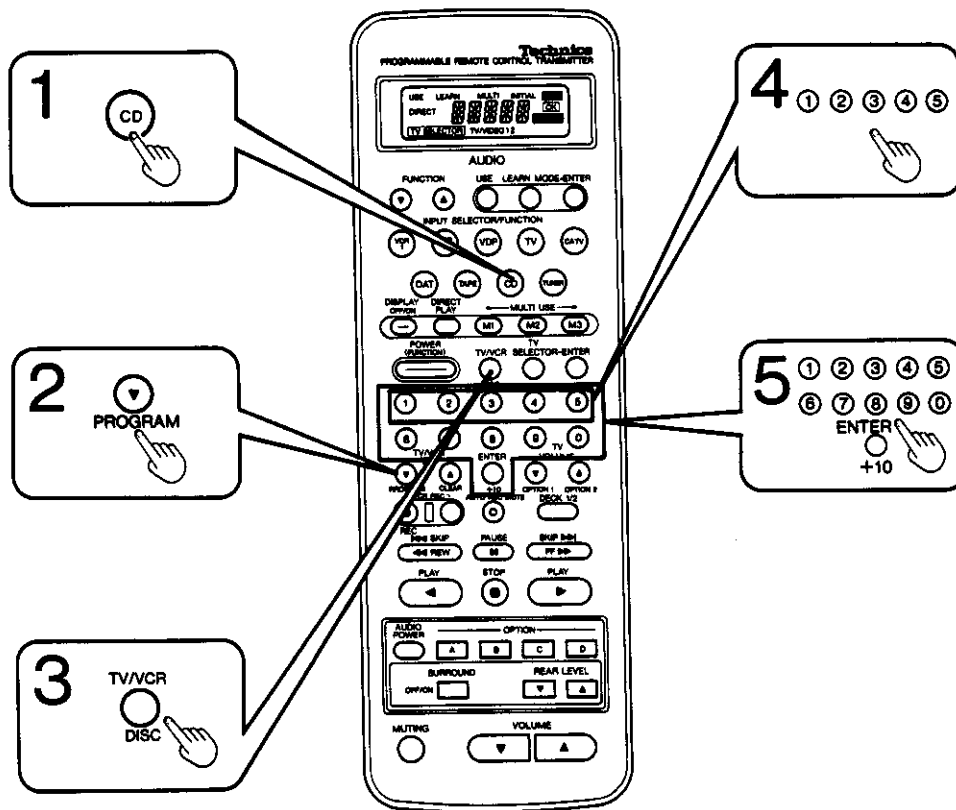

## Listening to compact discs (continued)

### Direct access play

To start sequential play from a specific disc and track. Play will progress to the last track of the last disc.

Steps 3 and 4 are only applicable to a Technics multi-compact disc player.

**1 Press the "CD" input/function select key.**

**2 Set the program/continue key to the continuous mode.**

(The program indicator of the compact disc player will not illuminate)

**3 Press the disc key.**

**4 Select the desired disc number.**

If only the disc is selected, play of all tracks on that disc (beginning from its first track) will begin.

**5 Select the desired track number.**

(Play will start.)

**To select a two-digit track number:**

Press the **+10** key to select the "tens" digit, and then one of the **0-9** keys to select the "units" digit.

**To select track number such as 30:**

Press the **+10** key three times to select 3, and then **0**.

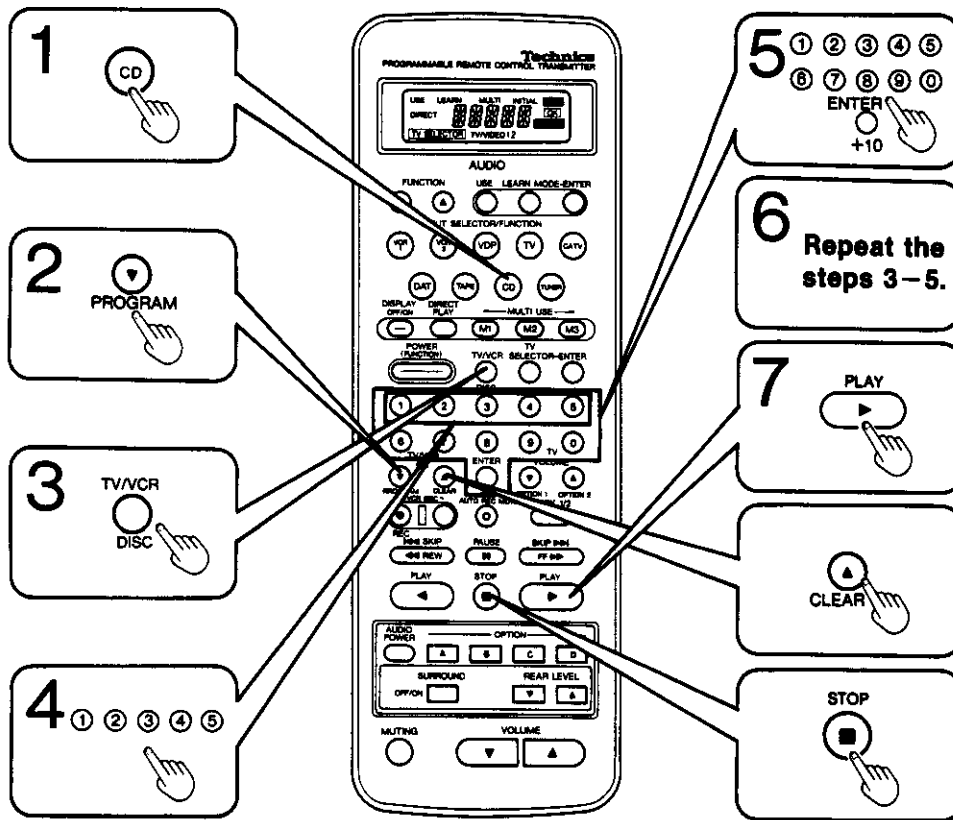

## Program play

The desired tracks from a desired disc can be programmed to play in any desired sequence.

- 1 Press the "CD" input/function select key.**
- 2 Set the program/continue key in the program mode.**  
(The program indicator of the compact disc player will illuminate.)
- 3 Press the disc key.**
- 4 Select the desired disc number.**  
Steps 5 and 6 are not necessary if selecting the disc only.
- 5 Select the desired track number.**  
**To select a two-digit track number:**  
Press the **+10** key to select the "tens" digit, and then one of the **0-9** keys to select the "units" digit.  
**To select a track number such as 30:**  
Press the **+10** key three times to select 3, and then **0**.
- 6 Repeat steps 3-5 until the desired program is completed.**
- 7 Press the play key.**  
(Play will start.)

## To clear a program entry

### Press the clear key.

Each time the clear key is pressed, the last selection in the program sequence will be cancelled.



## To clear the entire program

Press the stop key one time while programming or two times while in the program play mode.



# Remote-Control Operation (Audio)

(continued)

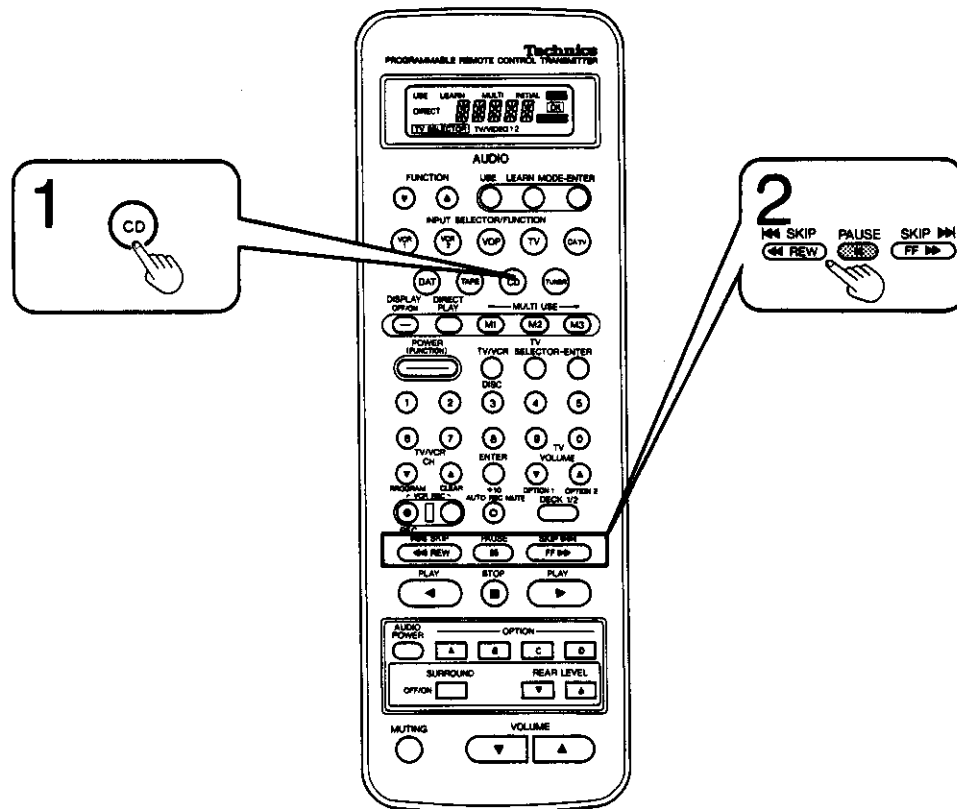

## Listening to compact discs (continued)

### Skip play

Press one of the skip keys during play.

- 1 Press the "CD" input/function select key.
- 2 Press the skip key momentarily until the desired track has been located.

SKIP Pickup skips forward.

SKIP REW Pickup skips backward.

During program play, the pickup skips forward or backward within the programmed tracks.



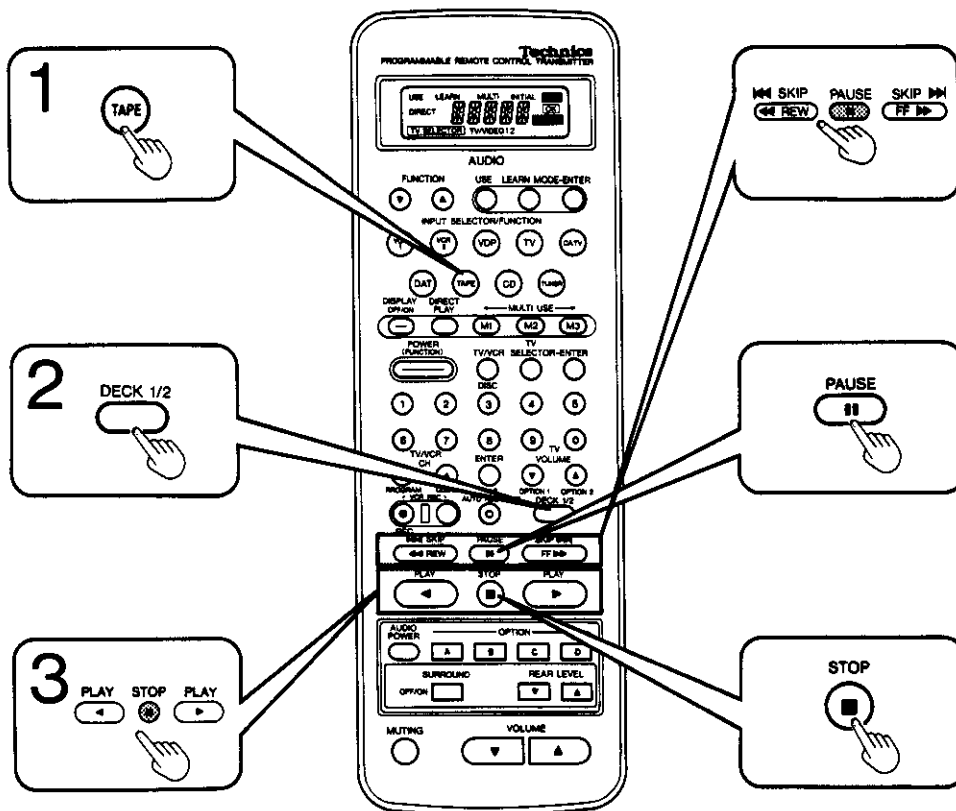

## Listening to tapes

For Technics tape decks with the proper remote-control terminal only. Consult your dealer for details.

**1 Press the "TAPE" input/function select key.**

**2 Select tape deck (1 or 2).**

**3 Press the appropriate playback key.**

▶: For the "A"-side of the tape  
◀: For the "B"-side of the tape

## To search for the desired tune

Press one of the fast-forward/cue, rewind/review keys during playback.

During playback of side "A" (forward) (▶):

◀◀ REW: Press to review.

FF ▶▶: Press to cue.

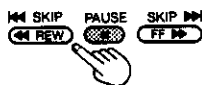

For Technics tape decks with the "music select" functions, these keys can be used to select the desired tune during playback.

During playback of side "B" (reverse) (◀):

◀◀ REW: Press to cue.

FF ▶▶: Press to review.

## To fast-forward or rewind the tape

Press one of the fast-forward/cue, rewind/review keys while in the stop mode.

If the side "A" (forward) indicator is illuminated:

◀◀ REW: Press to rewind.

FF ▶▶: Press to fast-forward.

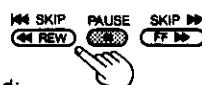

If the side "B" (reverse) indicator is illuminated:

◀◀ REW: Press to fast-forward.

FF ▶▶: Press to rewind.

## To stop playback temporarily

**Press the pause key.**

Press the playback key to resume playback.



## To stop playback

**Press the stop key.**



# Remote-Control Operation (Audio)

(continued)

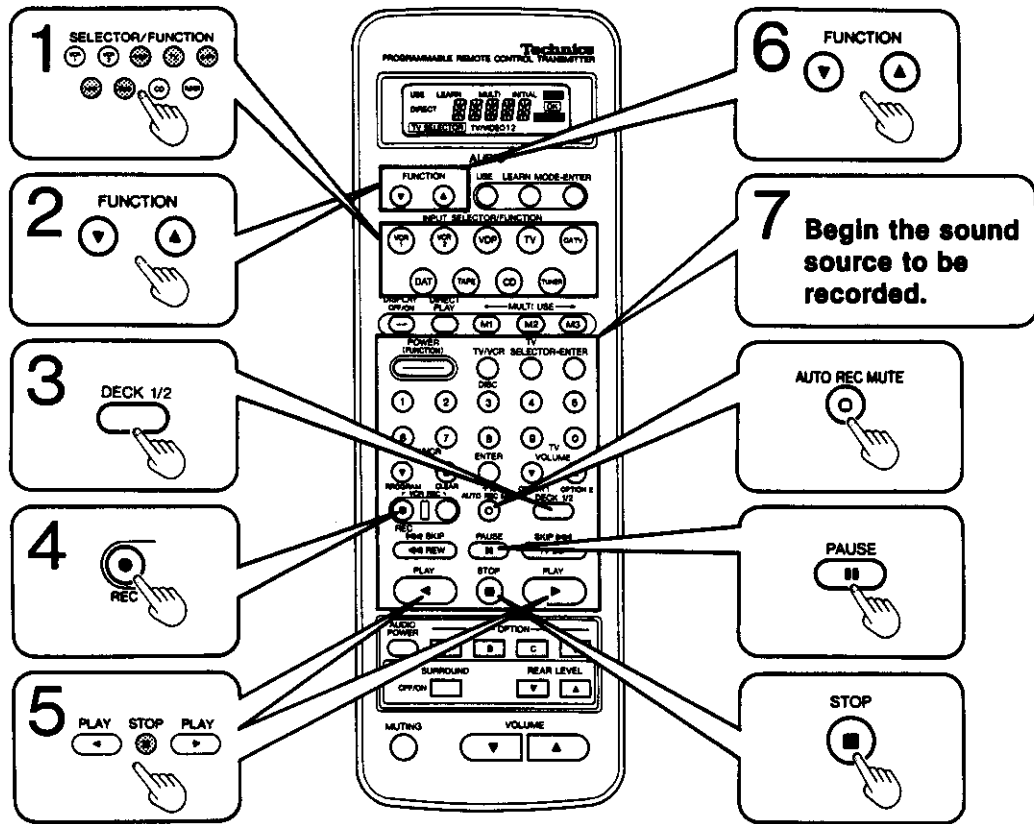

## Recording on tape deck

For Technics tape decks with the proper remote-control terminal only. Consult your dealer for details.

Before recording, prepare the tape deck for recording (recording level adjustment, etc.)

**1 Select the sound source to be recorded.**

**2 Select "TAPE".**

**3 Select tape deck (1 or 2).**

**4 Press the record key.**

(The tape deck will be in the recording stand-by mode.)

**5 Press the appropriate playback key to begin the recording.**

▶: For the "A"-side of the tape

◀: For the "B"-side of the tape

**6 Select the desired sound source.**

**7 Begin the sound source to be recorded.**

## To make an unrecorded passage during recording

Select "TAPE" by the function select keys (step 2 above) and then press the auto rec mute key.

(After 4 seconds, the tape deck will automatically change to the recording stand-by mode.)

To start the recording again, press the playback key.



## To stop recording temporarily

Select "TAPE" by the function select keys (step 2 above) and then press the pause key.

Press the playback key to resume recording.



## To stop recording

Select "TAPE" by the function select keys (step 2 above) and then press the stop key.



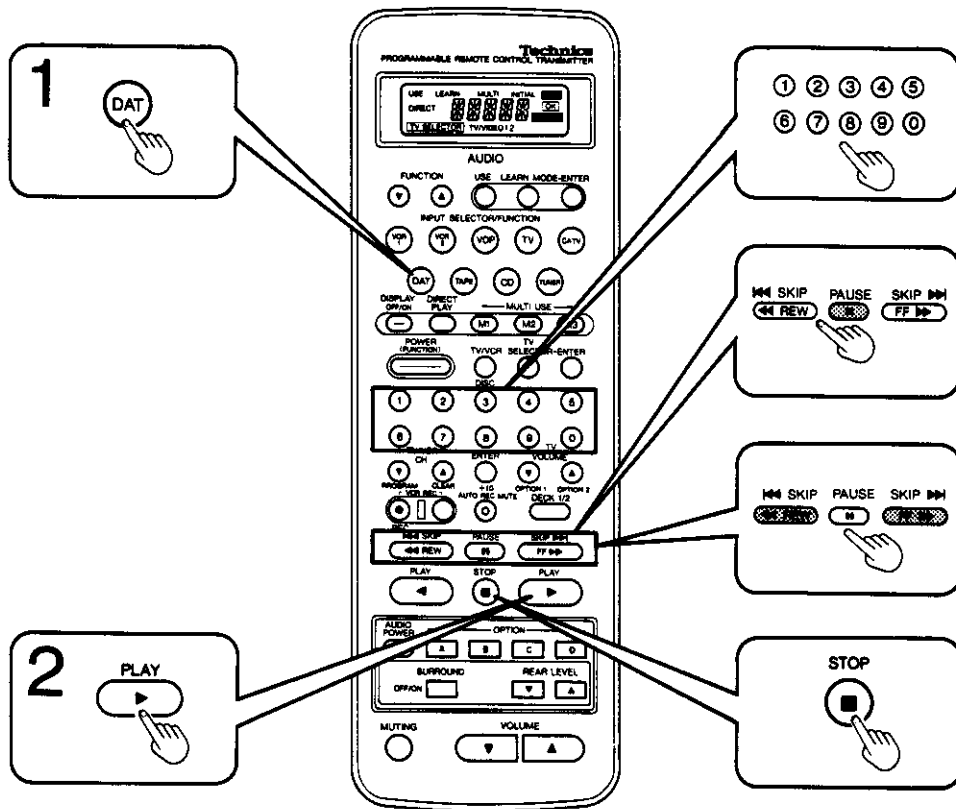

## Listening to digital audio tapes

For remote-control compatible Technics digital audio tape decks (DAT) only. Consult your dealer for details.

**1** Press the "DAT" input/function select key.

**2** Facing toward the DAT:  
Press the play key.  
(Play will start.)

## To start playback from the desired tune

**Facing toward the DAT:**

Select the desired tune number by pressing the appropriate numeric key and then press the play key.

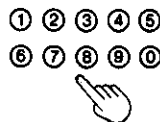

## To fast-forward or rewind the tape

**Facing toward the DAT:**

Press one of the fast-forward, rewind keys while in the stop mode.

◀◀ REW: Press to rewind.

FF ▶▶: Press to fast-forward.

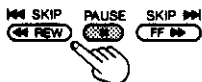

For Technics DAT with the "cue/review" functions, these keys can be used to search for the desired tune during playback.

## To stop playback temporarily

**Facing toward the DAT:**

Press the pause key.

Press the playback key to resume playback.



## To stop playback

**Facing toward the DAT:**

Press the stop key.



# Remote-Control Operation (Audio)

(continued)

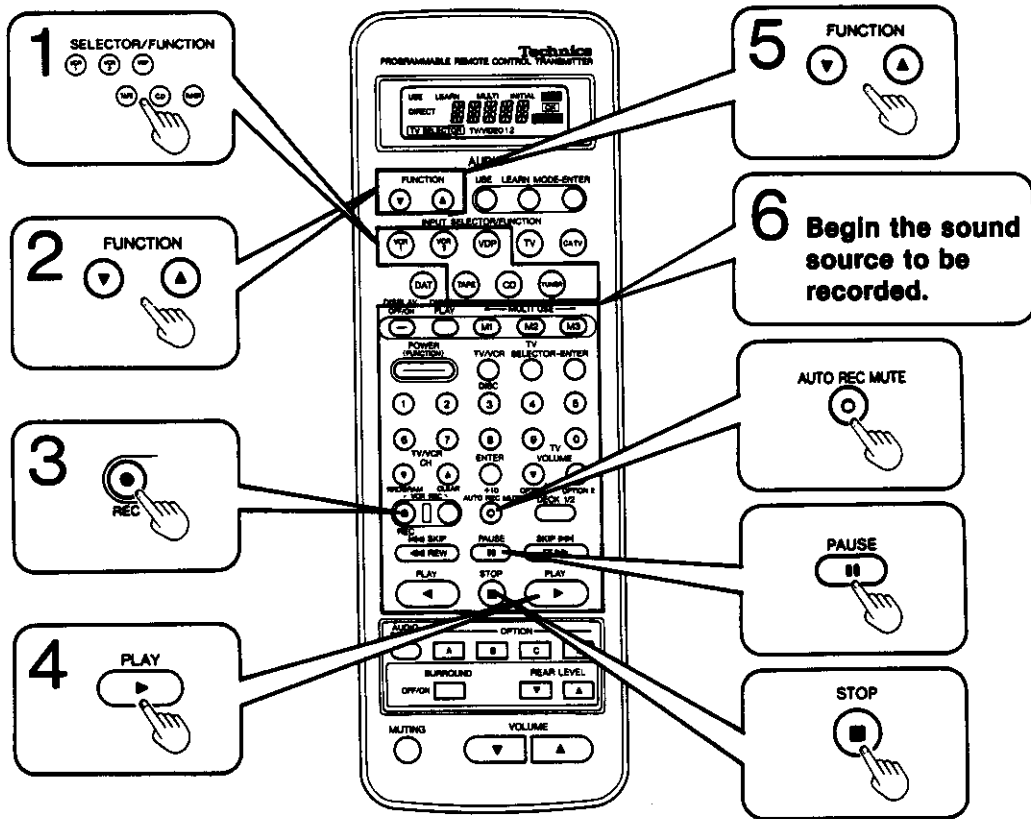

## Recording on digital audio tape decks (DAT)

For remote-control compatible Technics digital audio tape decks (DAT) only. Consult your dealer for details.

Before recording, prepare the DAT for recording (recording level adjustment, etc.)

- 1 Select the sound source to be recorded.
- 2 Select "DAT".

- 3 Facing toward the DAT:  
Press the record key.  
(The DAT will be in the recording stand-by mode.)
- 4 Facing toward the DAT:  
Press the playback key to begin the recording.
- 5 Select the desired sound source.
- 6 Begin the sound source to be recorded.

## To make an unrecorded passage during recording

Facing toward the DAT:

Select "DAT" by the function select keys (step 2 above) and then press the auto rec mute key.

(After 4 seconds, the DAT will automatically change to the recording stand-by mode.)

To start the recording again, press the playback key.



## To stop recording temporarily

Facing toward the DAT:

Select "DAT" by the function select keys (step 2 above) and then press the pause key.

Press the playback key to resume recording.



## To stop recording

Facing toward the DAT:

Select "DAT" by the function select keys (step 2 above) and then press the stop key.



# Remote-Control Operation (Video)

Have you connected the VCR and TV as indicated on pages 5-7?

This remote-control transmitter can control any Panasonic television or VCR which is equipped with remote-control functions that have been introduced since 1984.

When operating the TV and VCR, face the remote-control transmitter toward the remote-control signal receptor of each unit.

If there are two or more VCRs made by the same company, the VCRs will operate at the same time when the remote control is operated, so remove the tape from the VCR that is not being used.

For detailed information concerning TV or VCR operation, please read the operating instructions for each unit carefully.

## Watching TV broadcasts

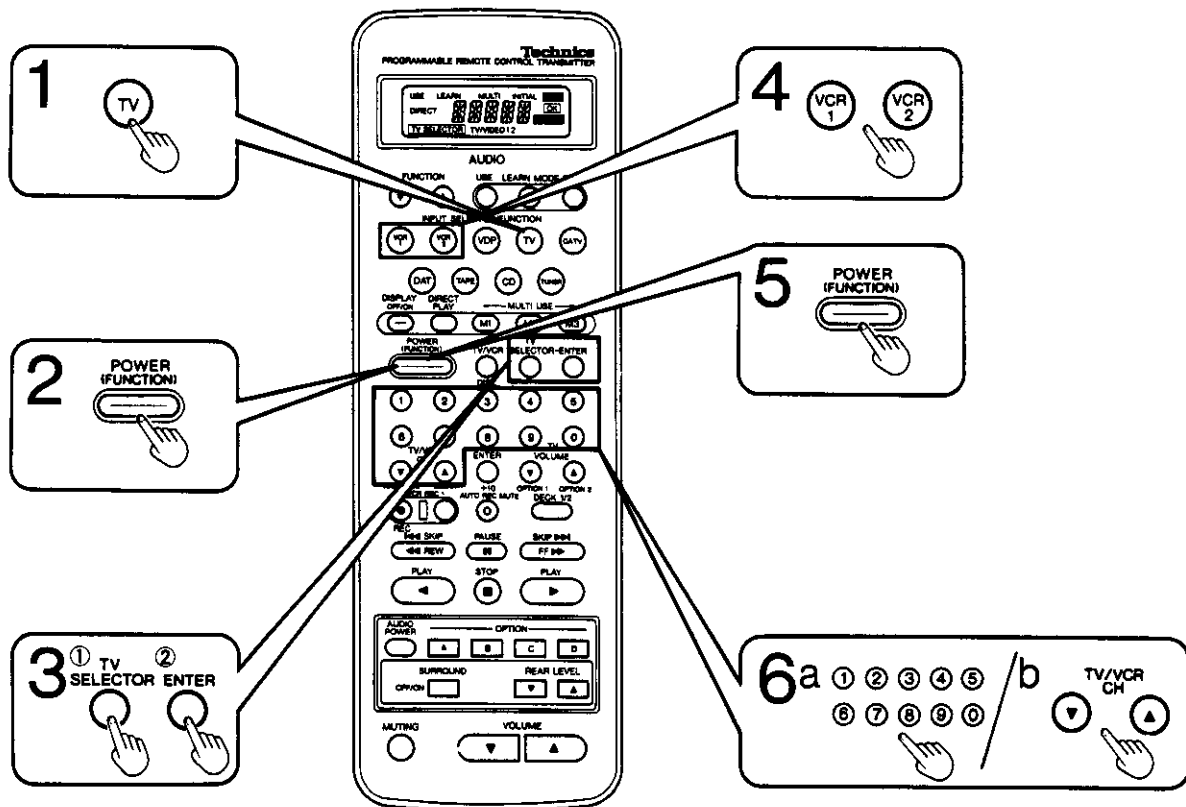

1 Press the "TV" input/function select key.

2 Facing toward the TV:  
Press the power key.  
(Power for TV will be switched ON.)

3 Facing toward the TV:  
Set the TV/VIDEO mode on the TV to "VIDEO".  
① Select the "TV/VIDEO" mode by the left key.  
② Press the right key.

4 Press the "VCR 1" (or "VCR 2") key.

5 Facing toward the VCR:  
Press the power key.  
(Power for VCR will be switched ON.)

6 Facing toward the VCR:  
Select the desired channel.

a When using the preset channel keys.  
Press two keys consecutively to tune to the desired TV broadcast directly.

b When using the channel up/down keys.  
Press "▼ CH" or "CH ▲" to select the desired channel.

# Remote-Control Operation (Video)

(continued)

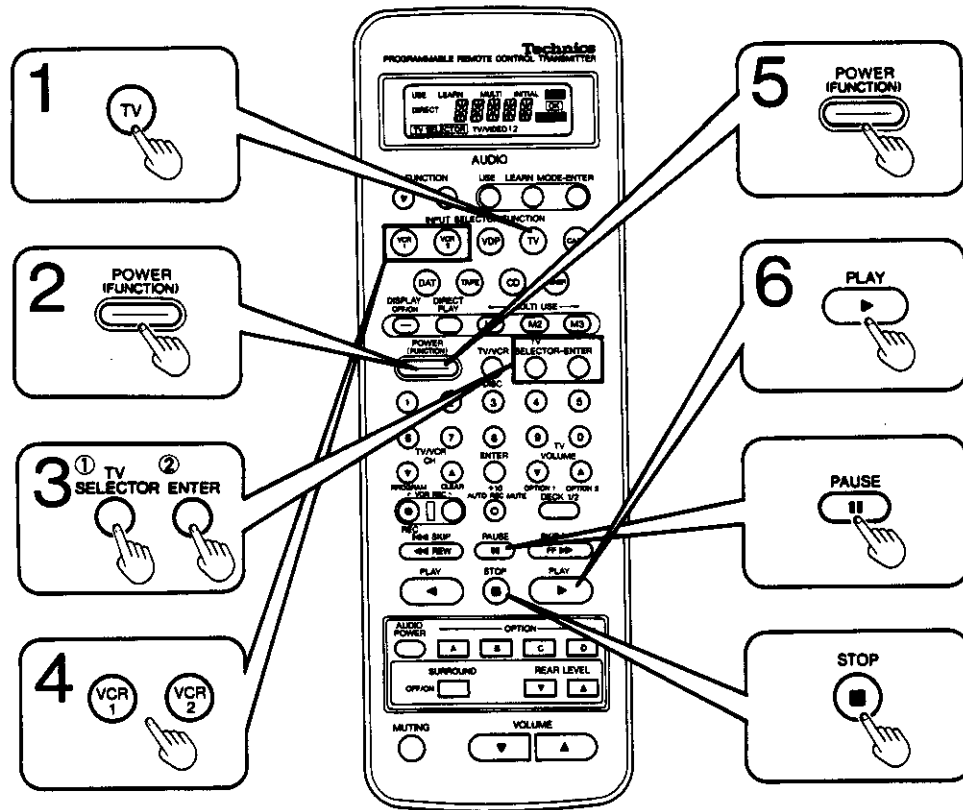

## Watching video tapes

- 1 Press the "TV" input/function select key.
- 2 Facing toward the TV:  
Press the power key.  
(Power for TV will be switched ON.)
- 3 Facing toward the TV:  
Set the TV/VIDEO mode on the TV to "VIDEO".  
① Select the "TV/VIDEO" mode by the left key.  
② Press the right key.
- 4 Press the VCR 1 or VCR 2 key.
- 5 Facing toward the VCR:  
Press the power key.  
(Power for VCR will be switched ON.)
- 6 Facing toward the VCR:  
Press the play key.  
(Playback will begin.)

## To stop playback temporarily

Facing toward the VCR:  
Press the pause key.  
Press again to start the playback



## To stop playback

Facing toward the VCR:  
Press the stop key.



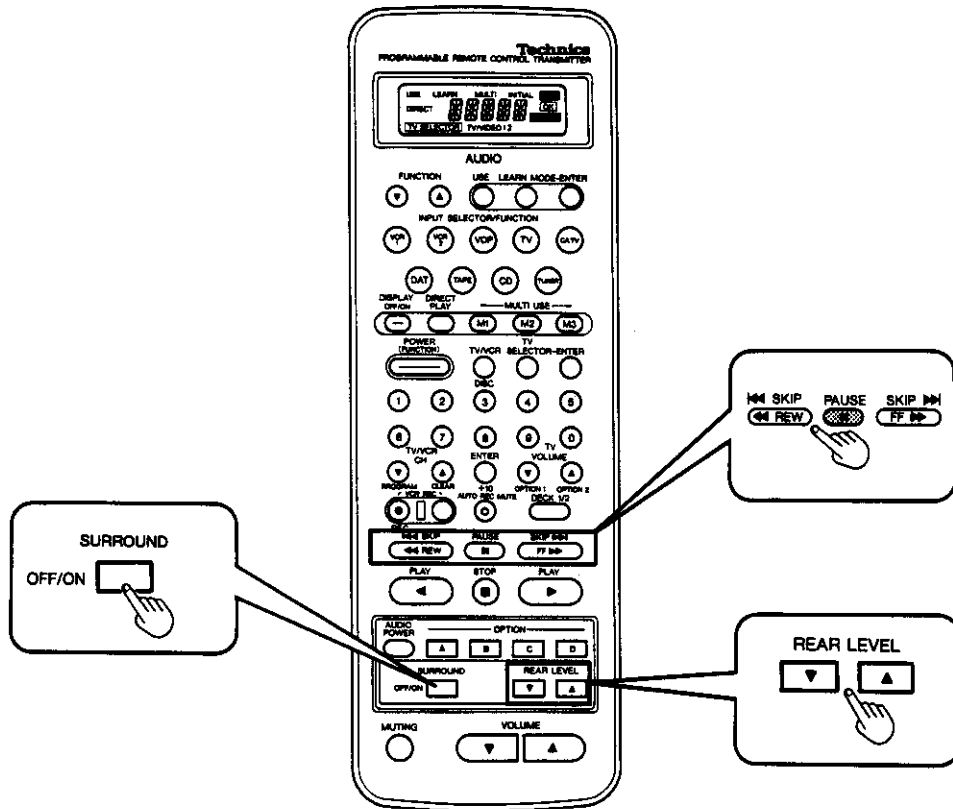

## To fast-forward or rewind the video tape

### Facing toward the VCR:

Press one of the fast-forward/cue, rewind/review keys while in the stop mode.

◀◀ REW: Press to rewind.

FF ▶▶: Press to fast-forward.

## To activate the surround effect

### Press the surround ON/OFF key.

(The surround indicator on the receiver will illuminate.)

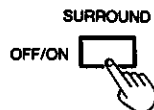

## To adjust the rear volume level

### Adjust the volume level of the rear speakers as desired.

The volume level of the rear speakers will be displayed on the rear level indicator.



# Remote-Control Operation (Video)

(continued)

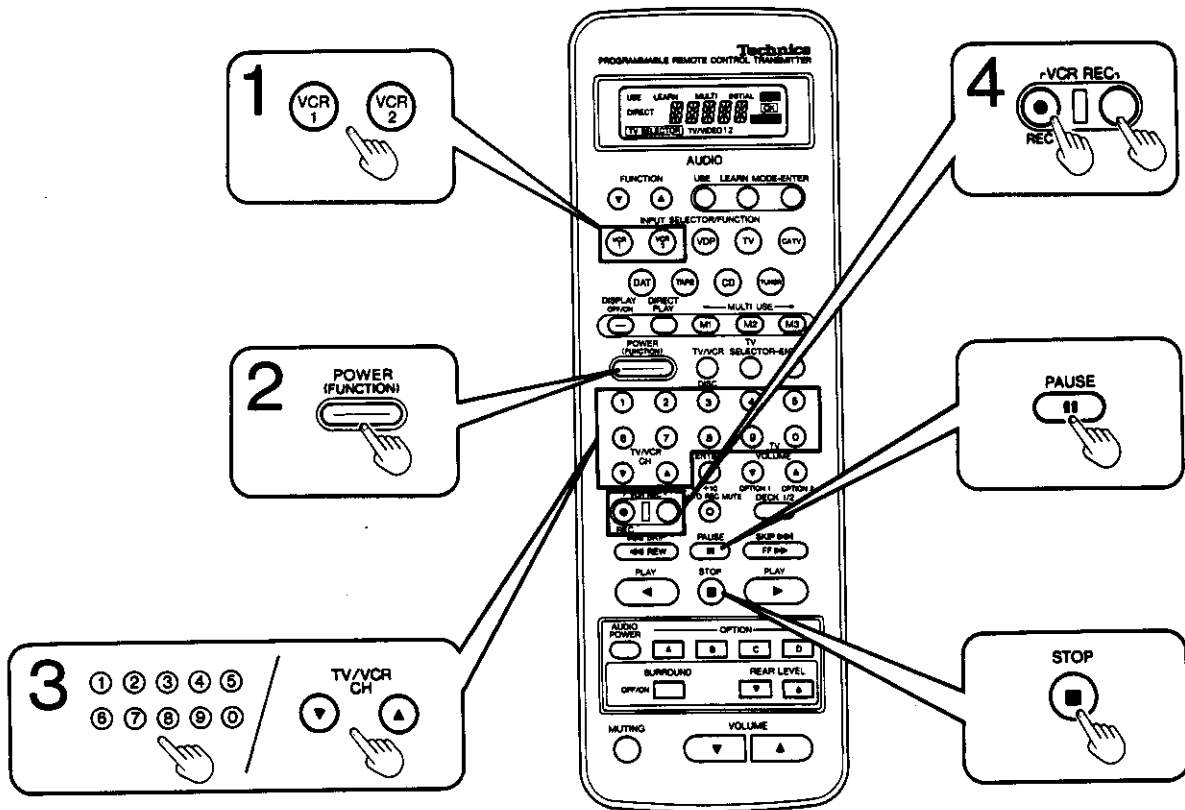

## Recording of TV broadcasts

Before recording, prepare the VCR for recording.  
Be sure to set the input selector on the VCR to the tuner position.

- 1 Press the "VCR 1" (or "VCR 2") input/function select key.
- 2 Facing toward the VCR:  
Press the power key.
- 3 Facing toward the VCR:  
Select the desired channel.
- 4 Facing toward the VCR:  
Press these keys simultaneously.  
(Recording will begin.)

## To stop recording temporarily

Facing toward the VCR:  
Press the pause key.  
Press again to start the recording.



## To stop recording

Facing toward the VCR:  
Press the stop key.





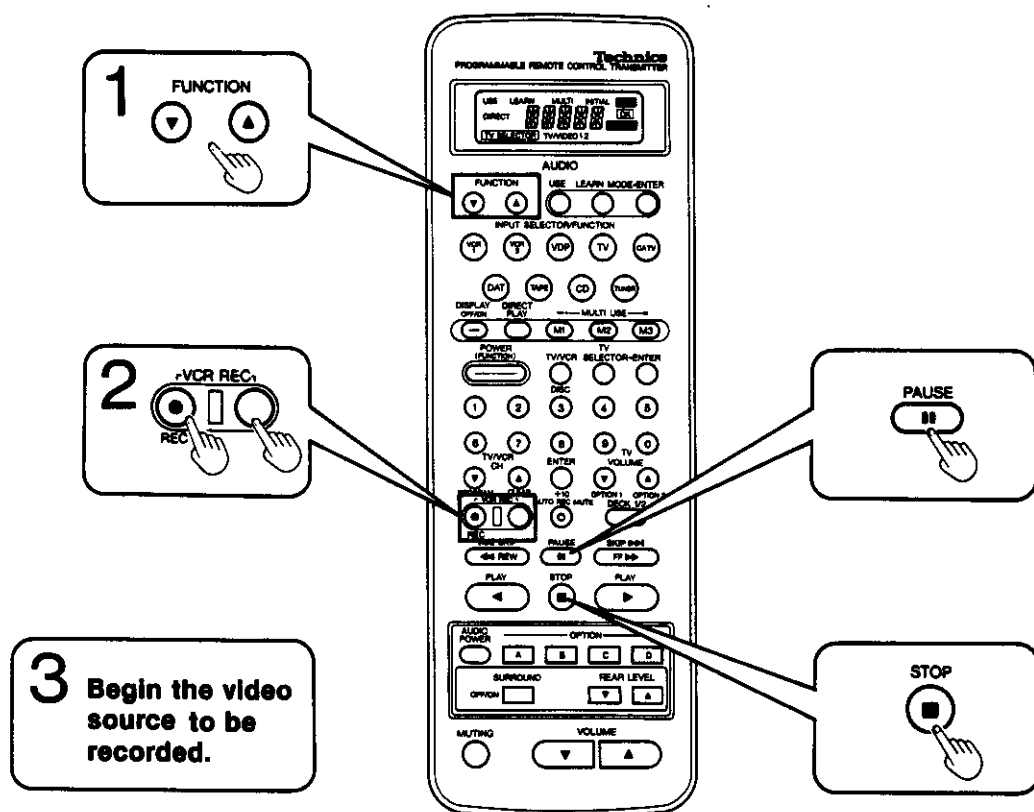

## Recording of video discs

Before recording, prepare the VCR 1 (or VCR 2) for recording. Be sure to set the input selector on the VCR to the external input position.

**1** Select "VCR 1" (or "VCR 2").

**2** Facing toward the VCR:  
Press these keys simultaneously.  
(Recording will begin.)

**3** Begin the video source to be recorded.  
(Refer to pages 58–60.)

**Note:**  
When recording from VCR to VCR, the operation must be done on a VCR and not on the remote control unit.

## To stop recording temporarily

Facing toward the VCR:  
Select "VCR 1" (or "VCR 2") by the function select keys (step 2 above) and then press the pause key. Press again to start the recording.



## To stop recording

Facing toward the VCR:  
Select "VCR 1" (or "VCR 2") by the function select keys (step 2 above) and then press the stop key.



# Remote-Control Operation (Video)

(continued)

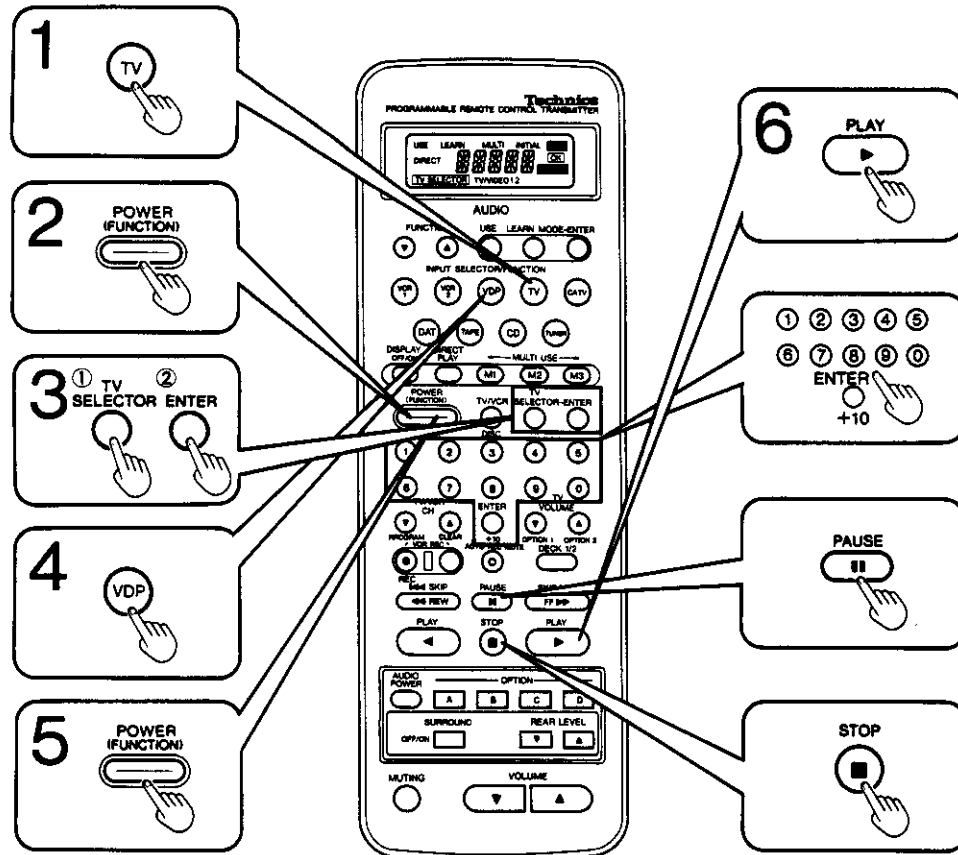

## Watching video discs

For remote-control compatible Panasonic video disc players only.  
Consult your dealer for details.

- 1 Press the "TV" input/function select key.
- 2 Facing toward the TV:  
Press the power key.  
(Power for TV will be switched ON.)
- 3 Facing toward the TV:  
Set the TV/VIDEO mode on the TV to "VIDEO".  
① Select the "TV/VIDEO" mode by the left key.  
② Press the right key.
- 4 Press the "VDP" input/function select key.
- 5 Facing toward the video disc player:  
Press the power key.  
(The power of video disc player will be switched ON.)
- 6 Facing toward the video disc player:  
Press the play key.  
(Play will start.)

## To watch from the desired chapter number

Facing toward the video disc player:  
Press the appropriate numeric key to select your desired chapter number

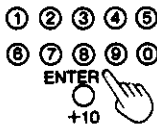

To select a two-digit chapter number:  
Press the [+10] key to select the "tens" digit, and then one of the [0]-[9] keys to select the "units" digit.  
To select a chapter number such as 30:  
Press the [+10] key three times to select 3, and then [0].

## To stop playback temporarily

Facing toward the video disc player:  
Press the pause key.  
Press again to start the playback.



## To stop playback

Facing toward the video disc player:  
Press the stop key.



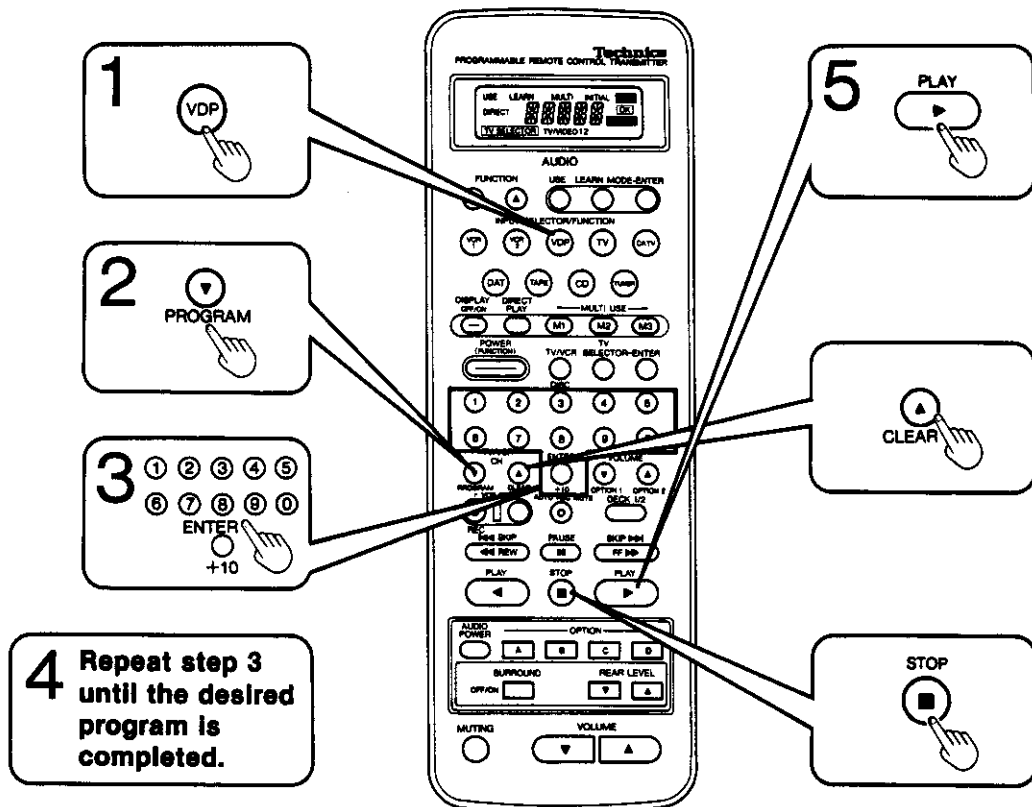

## Program play

- 1 Press the "VDP" input/function select key.
- 2 Facing toward the video disc player:  
Set the program/continue key in the program mode.  
(The program indicator of the video disc player will illuminate.)
- 3 Facing toward the video disc player:  
Select the desired chapter number.  
To select a two-digit chapter number:  
Press the [+10] key to select the "tens" digit, and then one of the [0]-[9] keys to select the "units" digit.  
To select a chapter number such as 30:  
Press the [+10] key three times to select 3, and then [0].
- 4 Repeat step 3 until the desired program is completed.
- 5 Facing toward the video disc player:  
Press the play key.  
(Play will start.)

## To clear a program entry

Facing toward the video disc player:

Press the clear key.

Each time the clear key is pressed, the last selection in the program sequence will be cancelled.



## To clear the entire program

Facing toward the video disc player:

Press the stop key one time while programming or two times while in the program play mode.



# Remote-Control Operation (Video)

(continued)

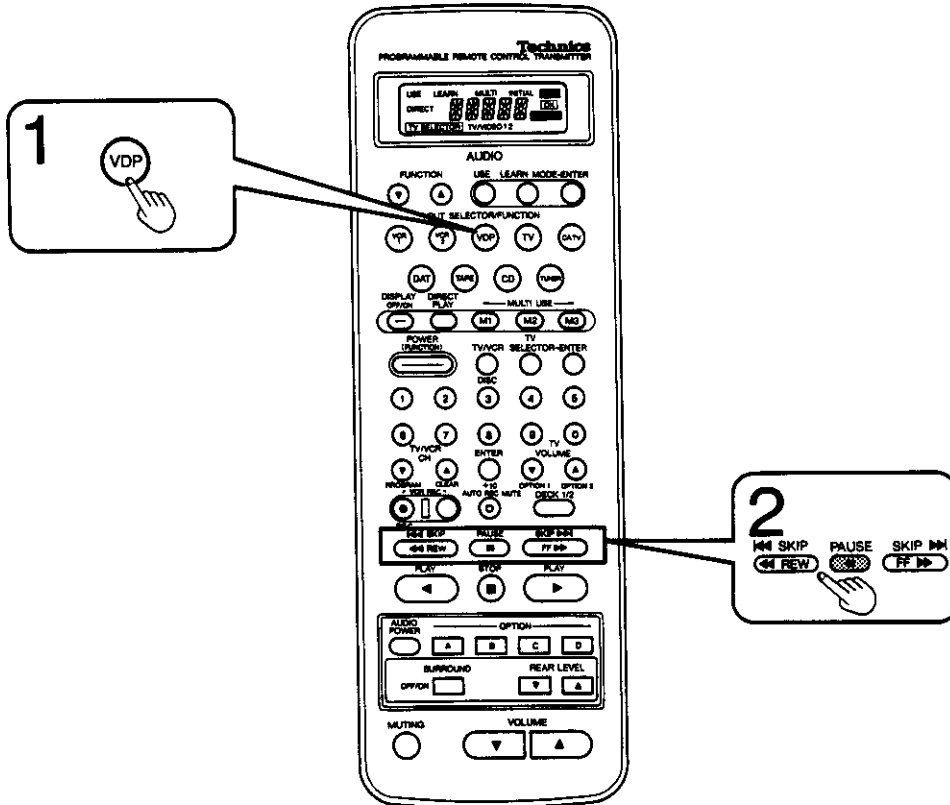

## Watching video disc (continued)

### Skip play

Press one of the skip keys during play.

- 1 Press the "VDP" input/function select key.
- 2 Facing toward the video disc player:  
Press the skip key momentarily until the desired track has been located.

SKIP Pickup skips forward.

SKIP  
 REW Pickup skips backward.

During program play, the pickup skips forward or backward within the programmed tracks.

# Remote-Control Operation (Other unit control)

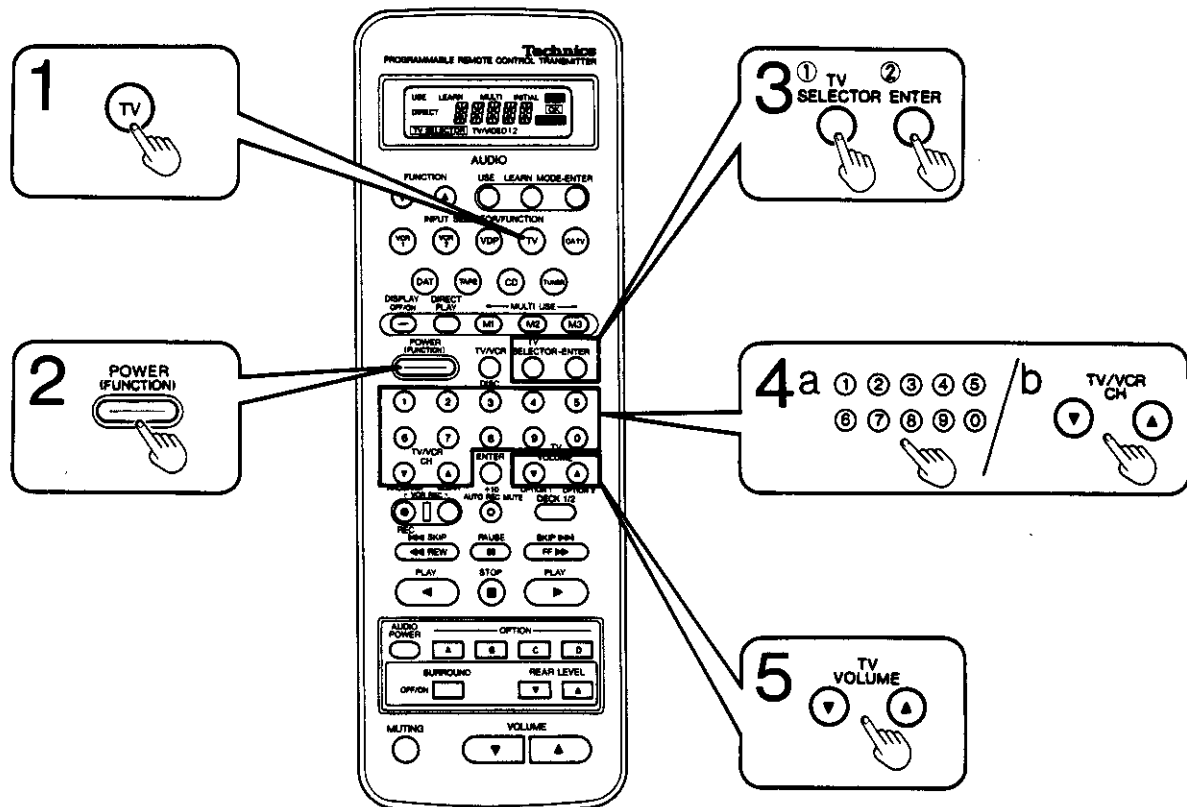

## Watching TV broadcasts

- 1 Press the "TV" input/function select key.
- 2 Press the power key.  
(Power for TV will be switched ON.)
- 3 Set the TV/VIDEO mode on the TV to "TV".
  - ① Select the "TV" mode by the left key.
  - ② Press the right key.
- 4 Select the desired channel.
  - a When using the preset channel keys.  
Press two keys consecutively to tune to the desired TV broadcast directly.
  - b When using the channel up/down keys.  
Press "▼ CH" or "CH ▲" to select the desired channel.
- 5 Adjust the volume level.

# Remote-Control Operation (Other unit control) (continued)

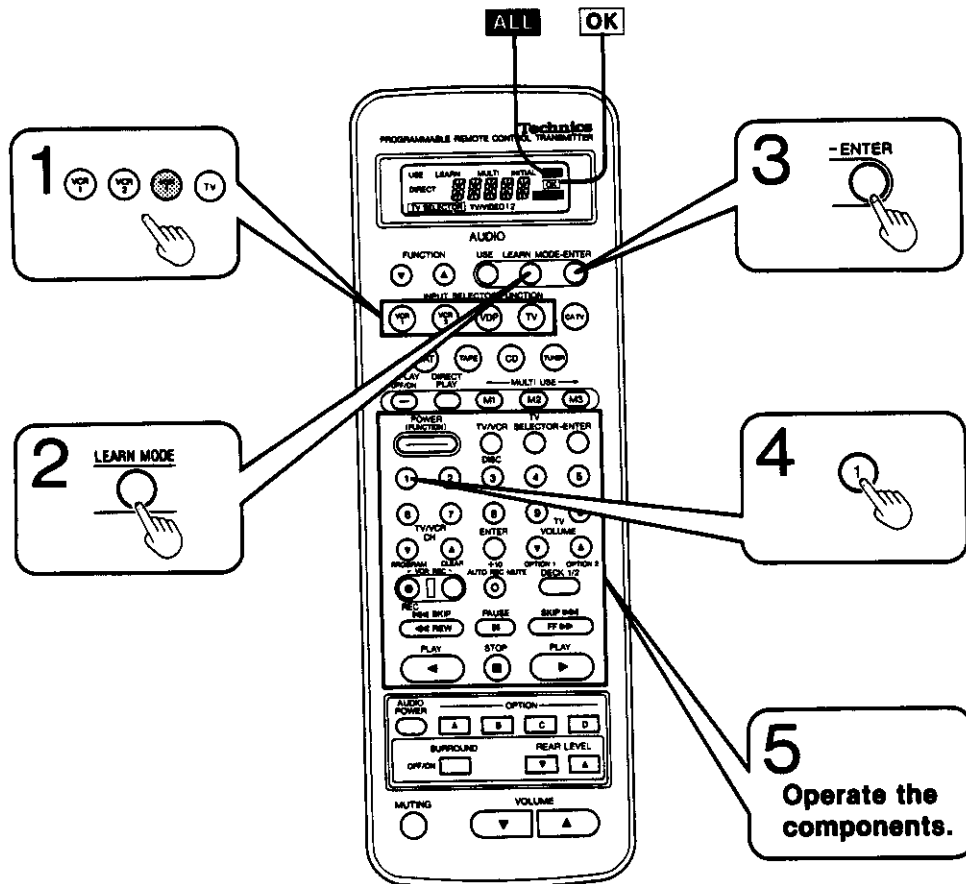

## To control an RCA VCR or TV

**1** Select the component to be operated.

**2** Select "ALL".  
(Press 4 times.)

**3** Press "ENTER".  
"ALL" will flash.

**4** Press and hold the ① key until the "OK" sign is indicated.

The "OK" sign indicates the remote-control codes are changed to the RCA codes.

**5** Operate the components.

Operation of the components is the same as Panasonic components.

Please see pages 53–57 and 61.

### Notes:

1. The remote-control codes for selection of TV/VIDEO mode are not programmed.
2. Some keys may not be functional, depending on the component itself.

## To return to Panasonic codes

Follow steps 2–3 above and press and hold the appropriate input/function select key (VCR 1, VCR 2 or TV) until the "OK" sign is indicated.

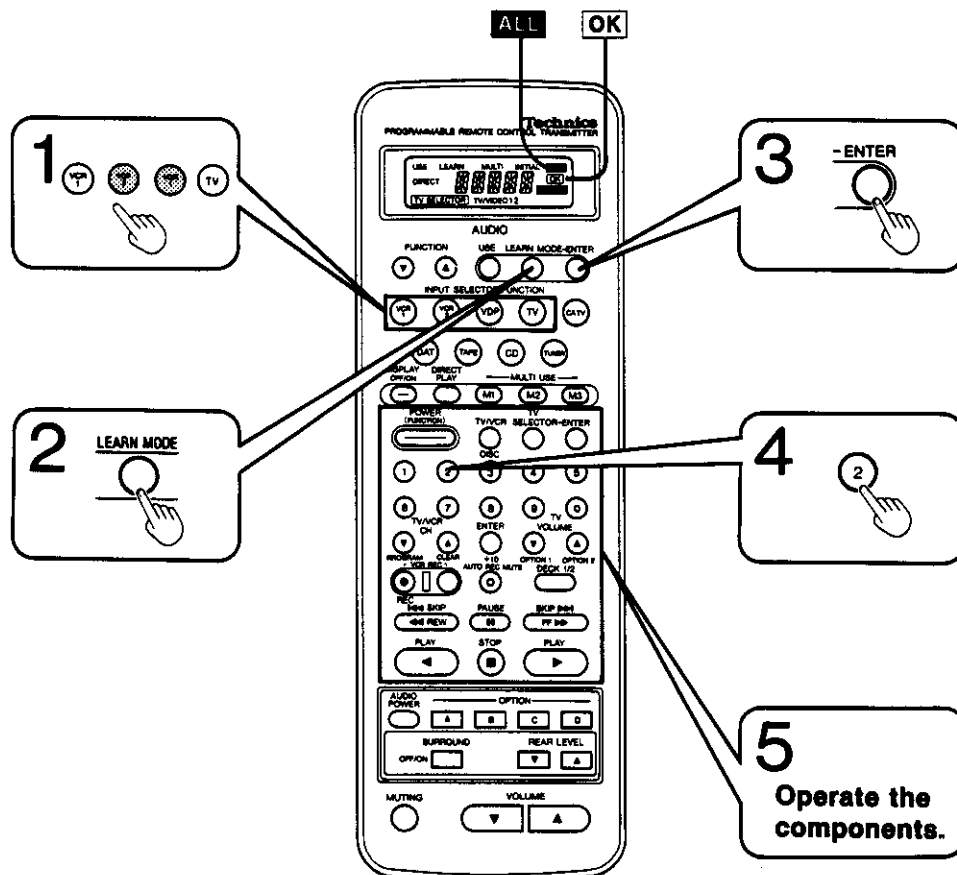

## To control a Zenith VCR or TV

**1** Select the component to be operated.

**2** Select "ALL".  
(Press 4 times.)

**3** Press "ENTER".  
"ALL" will flash.

**4** Press and hold the ② key until the "OK" sign is indicated.

The "OK" sign indicates the remote-control codes are changed to the Zenith codes.

**5** Operate the components.

Operation of the components is the same as Panasonic components.

Please see pages 53–57 and 61.

**Notes:**

1. To select a channel numbered 10 or higher, press the "enter" key after entering a channel number to change the channel instantly.
2. The remote-control codes for selection of TV/VIDEO mode are not programmed.
3. Some keys may not be functional, depending on the component itself.

## To return to Panasonic codes

Follow steps 2–3 above and press and hold the appropriate input/function select key (VCR 1 or TV) until the "OK" sign is indicated.

# Remote-Control Operation (Other functions)

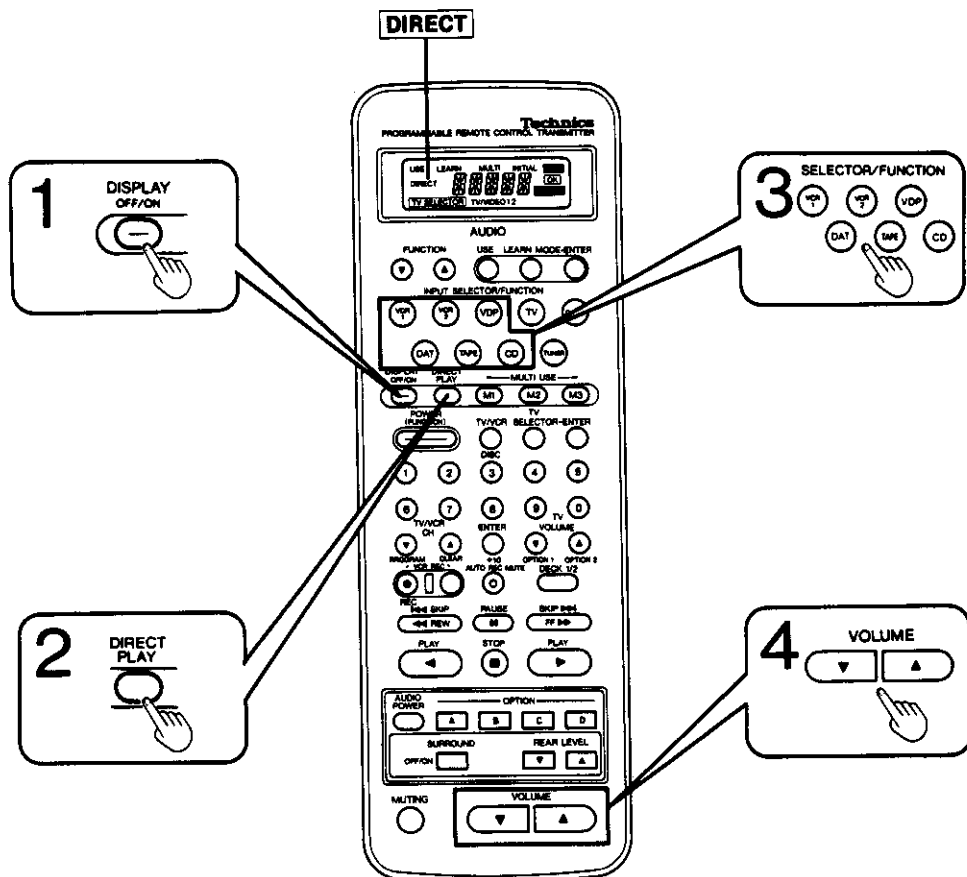

## To enjoy "Direct Play"

You can enjoy the audio/video source of your choice, simply by selecting the "DIRECT PLAY" key and pressing the input source/function select key.

(Switching over is unnecessary with PLAY or TV SELECT.)

### Notes:

1. Direct play is only possible with "VCR 1", "VCR 2", "VDP", "DAT", "TAPE", "CD".
2. When selecting an input in the direct play mode, press and hold the input/function select key until the display changes (may take 1 or 2 seconds).

**1 Switch ON the display.**

**2 Select "DIRECT PLAY".**

(The "DIRECT" indicator will illuminate.)

**3 Select the source of your choice.**

The programmed remote-control codes are transmitted as shown below.

Source	Details to be transmitted		
VCR 1	1 Input Select "VCR 1"	2 Video Input "VIDEO 1"	3 VCR 1 play
VCR 2	1 Input Select "VCR 2"	2 Video Input "VIDEO 1"	3 VCR 2 play
VDP	1 Input Select "VDP"	2 Video Input "VIDEO 1"	3 VDP play
DAT	1 Input Select "DAT"	2 DAT play	
TAPE	1 Input Select "TAPE"	2 tape play	
CD	1 Input Select "CD"	2 CD play	

### Note:

For an RCA and Zenith component, the Video input "VIDEO 1" code is not programmed.

**4 Adjust the volume level.**



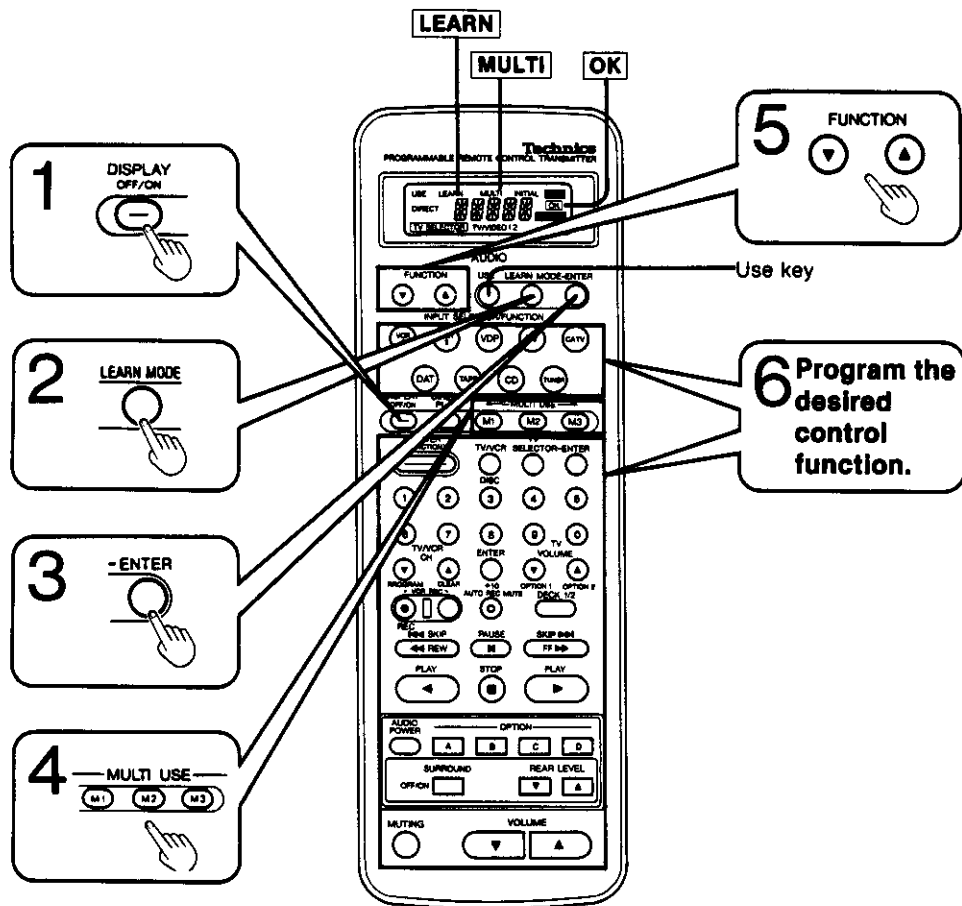

## To enjoy "Multi-Function play"

A series of codes (functions) can be stored as a "group" in one of the three "MULTI USE" memory keys. For example, you can use one of the keys to program VCR ON, TV ON, VCR PLAY controls in sequence.

Simply pressing the relevant multi-function key takes care of all these controls in a single operation, so you can start watching a video with one-touch convenience.

Three keys (M1, M2, M3) can store up to 8 controls each.

## To program the multi-function keys

- 1 **Switch ON** the display.
- 2 **Select "MULTI"**.  
(Press two times.)
- 3 **Press "ENTER"**.  
"MULTI" will flash.
- 4 **Select the key you want to program**.  
"MULTI" and "LEARN" will flash.
- 5 **Select the equipment to be controlled**.
- 6 **Program the desired control function**.  
**Repeat this step until all desired controls are programmed.**  
When the control is programmed correctly, the "OK" sign is displayed.  
When 8 control functions have been entered, the unit will return to the "use" mode.

## To stop programming

Press the "USE" key.

## To alter the program

Repeat the above procedures.  
(The previously programmed contents will be erased.)

# Remote-Control Operation (Other functions) (continued)

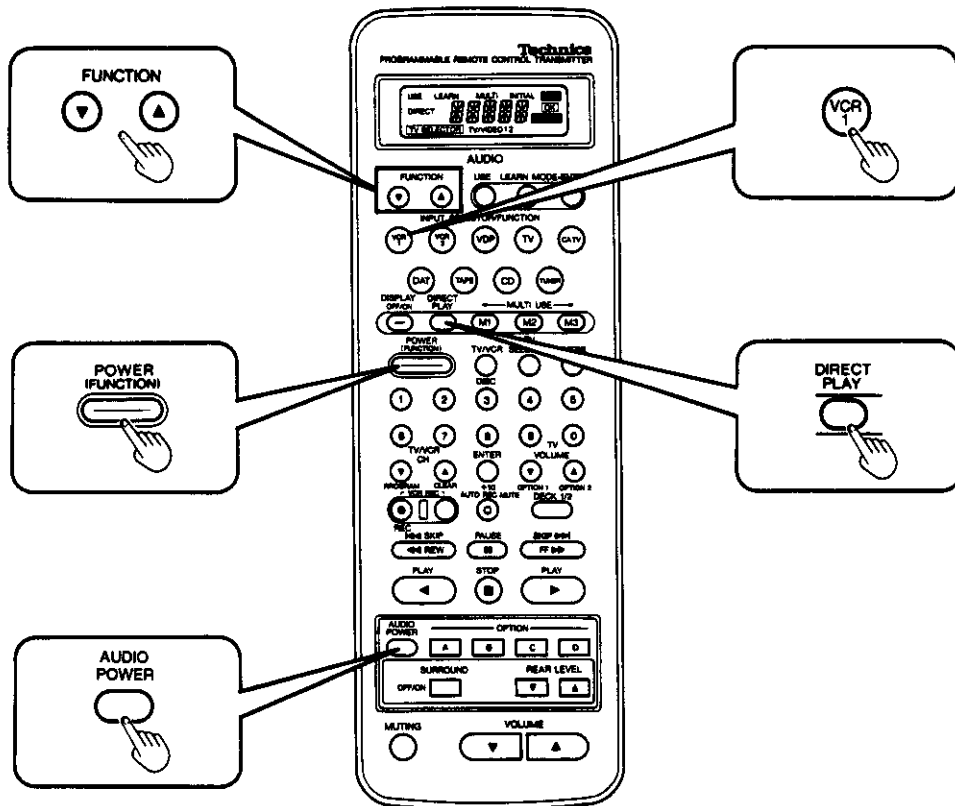

## To enjoy "Multi-Function Play" (continued)

### Suggested uses for programming

For example, for playing back a video, the whole process of switching ON the power to the actual replaying of the video can be carried out by following programming steps 1-4 with these programming details.

(In the following example, the programming number of controls is 4.)

#### Note:

When programming is being carried out, if the same equipment is operated after the power source is switched ON, there is a possibility that (depending on the equipment), the equipment might not operate. It is therefore suggested, as shown above, that after the power source is switched ON, the controls of other equipment are programmed.

	Operation	Details
1	(TV) FUNCTION → POWER (FUNCTION)	Switch ON the TV power.
2	AUDIO POWER	Switch ON the receiver power.
3	(VCR 1) FUNCTION → POWER (FUNCTION)	Switch ON the VCR power.
4	DIRECT PLAY → VCR 1	Receiver power input to "VCR 1". TV power input to "VIDEO 1". Playback of video tapes.

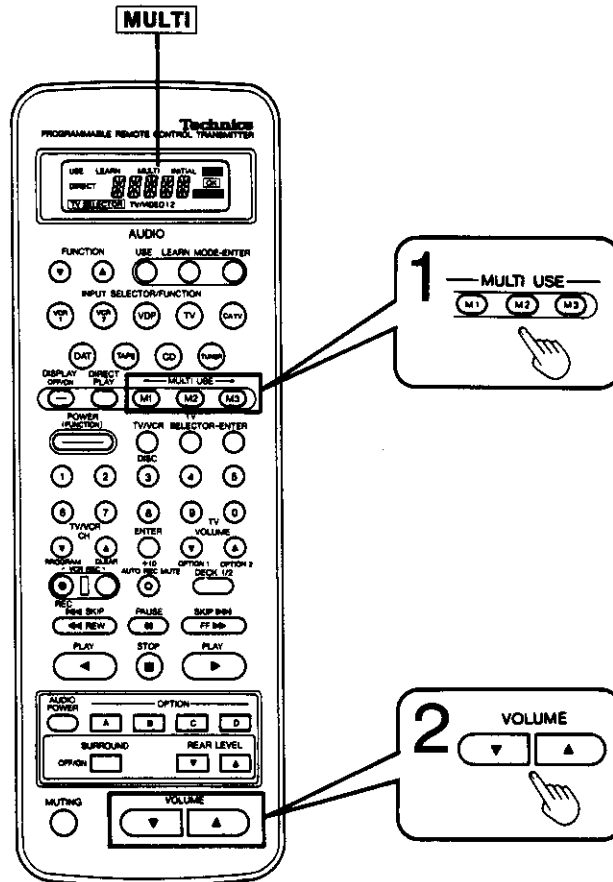

## To operate

- 1 Select the "MULTI USE" key.  
"MULTI" will illuminate.
- 2 Adjust the volume level.

**Care to be taken when the power is switched "ON" with the multi-function key.**

Make sure that the power source of the equipment to be operated has originally been switched "OFF" from the remote control.

(If the multi-function key is pressed "ON" while the power source is already "ON", the power will be switched "OFF".)

# Remote-Control Operation (Other functions) (continued)

## Code memorization

This remote-control transmitter has the capability of receiving transmission signals (remote-control codes) from other remote-control transmitters and to store them in its memory. This means that other remote-controlled components (i.e. TV and VCR) can be operated using this remote-control.

### Note:

The capability of storing codes from other remote-control transmitters is limited to those that are of the infrared type only. Furthermore, there are some remote-control transmitters that employ a special code system that may not be compatible with this unit.

## About keys which have memory function

Storing the remote-control codes in memory can be made by using the operation keys and optional keys (A, B, C, D). The remote-control codes which are assigned for each component by using the function select keys can be stored in the memory on the operating keys.

For example, 9 control-codes (VCR 1, VCR 2, VDP, TV, CATV, DAT, TAPE, CD, TUNER) can be memorized on the power key, and regardless of the component, 4 different kinds of control-codes can be memorized on the optional keys.

The component to be operated is not necessarily selected by the input/function select keys. It is recommended to store the remote-control codes of the component which are frequently used.

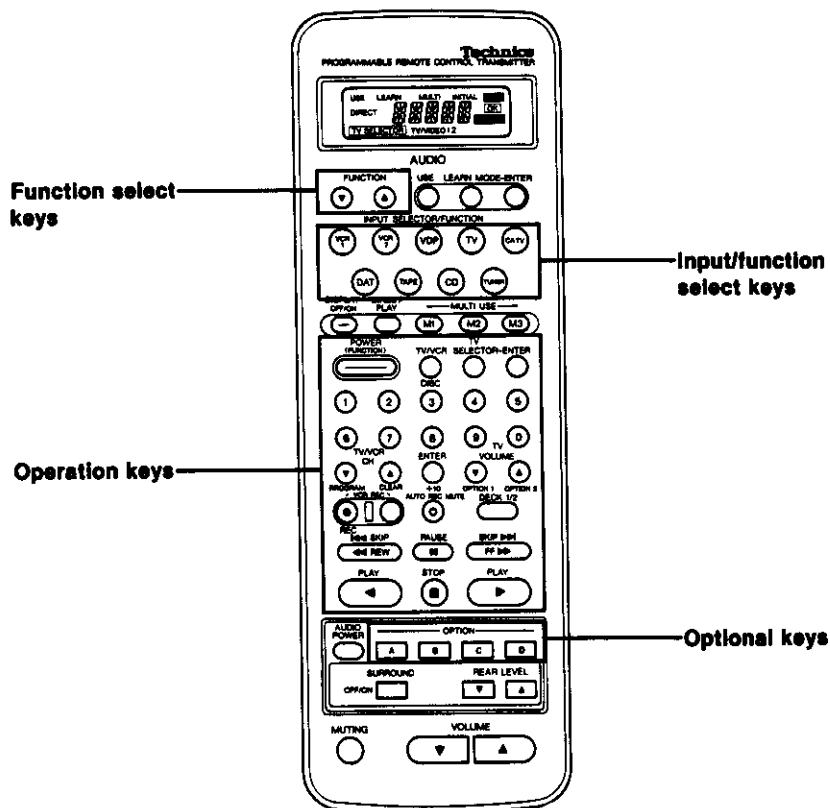

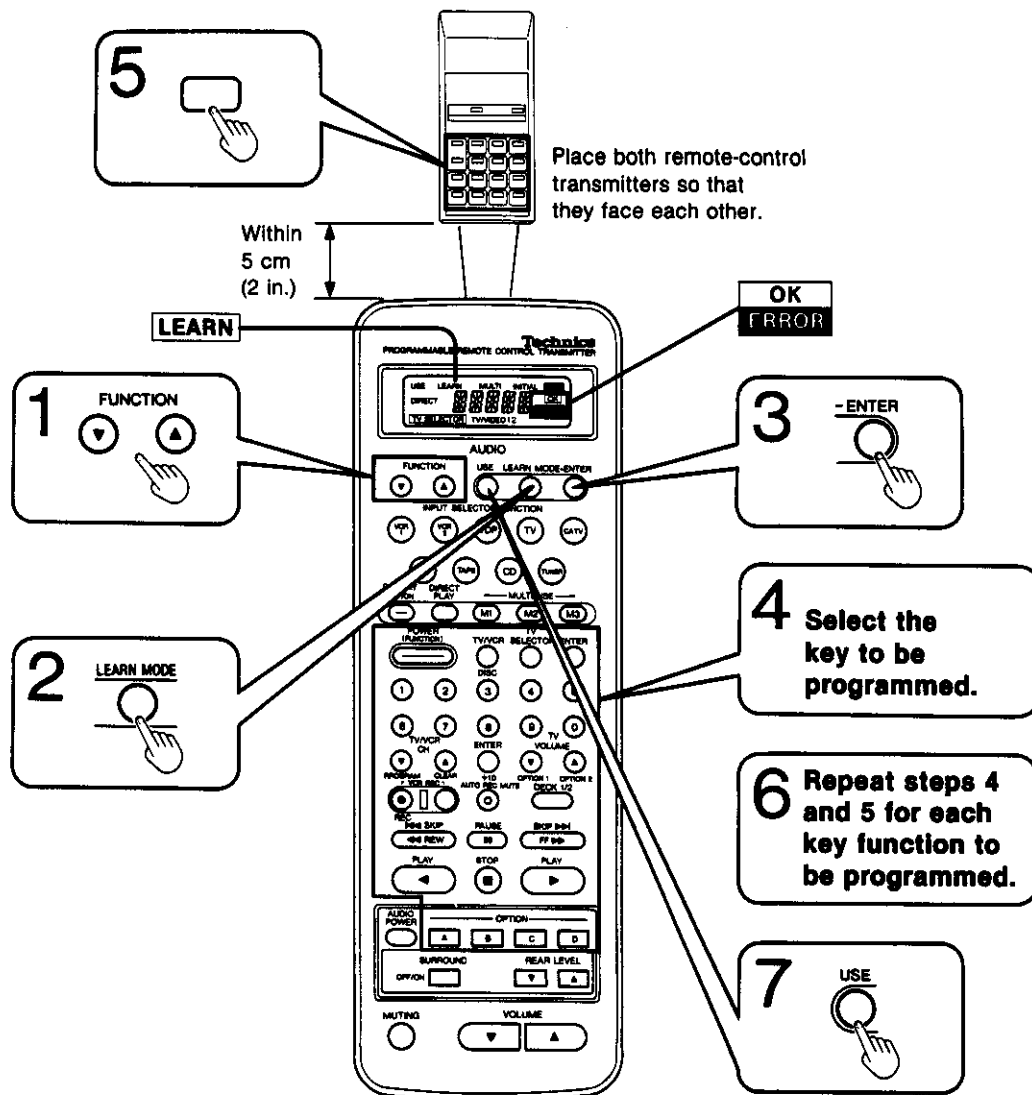

## To memorize codes

- 1 Select the component.**
- 2 Select "LEARN".**
- 3 Press "ENTER".**  
"LEARN" will flash.
- 4 Select the key to be programmed.**  
The "LEARN" will flash faster.  
**Notes:**
  1. For memorizing "VCR REC" keys in VCR 1 or VCR 2 mode, press two keys simultaneously.
  2. For memorizing "TV SELECTOR" key in TV mode, select the mode by the "TV SELECTOR" key and then press the "ENTER" key.
  3. It is recommended that, for your convenience, the optional keys (A, B, C, D) be used to memorize the codes that you often use.
  4. If the key, which is already assigned for memory, is pressed, the "ERROR" indicator will illuminate. This means the key can not be assigned to store memory.
- 5 Press and hold the key corresponding to the function to be memorized while the "LEARN" indicator flashes rapidly; hold the key until the "OK" indicator illuminates.**  
If the "ERROR" indicator illuminates, repeat steps 4 and 5 once again.
- 6 Repeat steps 4 and 5 for each key function to be programmed.**  
When changing the component to be memorized, select the desired component as described in step 1, and follow steps 4 and 5.  
  
To alter the program, cancel the memorized code (see page 70.) and then repeat the above procedures.
- 7 Press the "USE" key to return to the "USE" mode.**

# Remote-Control Operation (Other functions) (continued)

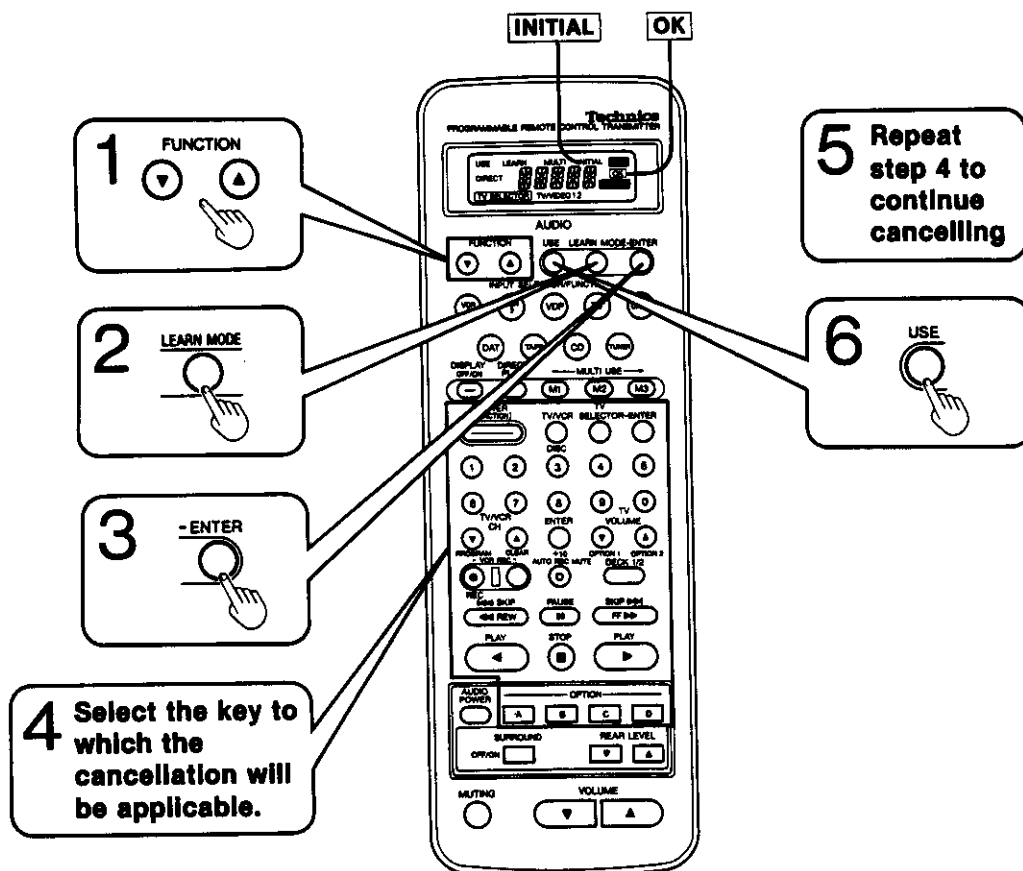

## Code erasure

### To cancel one code at a time

- 1** Select the component.
- 2** Select "INITIAL".  
(Press 3 times).
- 3** Press "ENTER".  
"INITIAL" will flash.
- 4** Select the key to which the cancellation will be applicable.  
When the code is cancelled correctly, the "OK" sign is displayed.
- 5** Repeat step 4 to continue cancelling.  
When changing the component to be cancelled, select the desired component by using the function select keys (step 1) and then follow step 4.
- 6** Press the "USE" key to return to the "USE" mode.

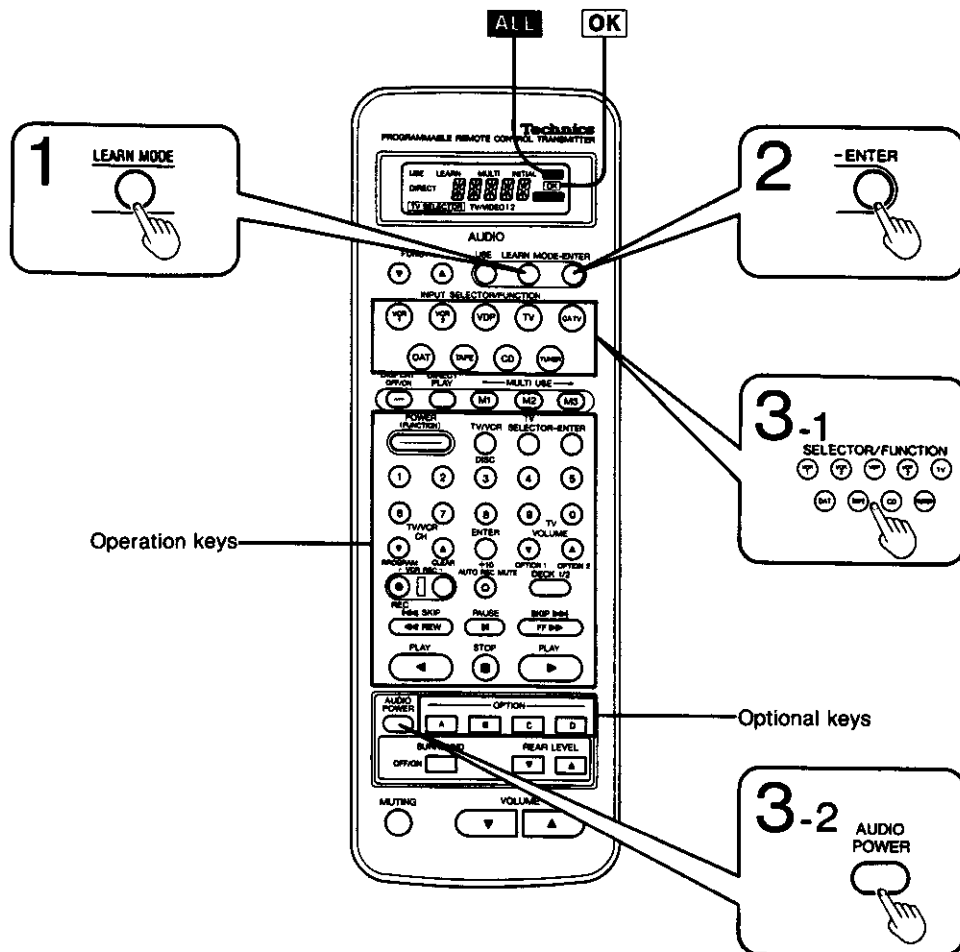

## To cancel by block

**1 Select "ALL".**  
(Press 4 times.)

**2 Press "ENTER".**  
"ALL" will flash.

**To cancel all operation keys unit by unit**

**3-1 Press and hold the key to which the cancellation will be applicable.**

When the codes are cancelled correctly, the "OK" sign is displayed and then the unit will return to the "USE" mode.

**To cancel all of optional keys**

**3-2 Press the "AUDIO POWER" key.**

When the codes are cancelled correctly, the "OK" sign is displayed and then the unit will return to the "USE" mode.

# Technical Specifications (IHF'78)

## ■ AMPLIFIER SECTION

**Rated minimum sine wave**  
**RMS power output**  
 20 Hz~20 kHz both channels driven  
**0.008% total harmonic distortion**  
 110 W per channel (8 Ω)

**1 kHz continuous power output**  
 both channels driven  
**0.008% total harmonic distortion** 115 W per channel (8 Ω)  
**Total harmonic distortion**  
 rated power at 20 Hz~20 kHz 0.008% (8 Ω)  
 half power at 1 kHz 0.002% (8 Ω)  
**Dynamic headroom** 1.2 dB (8 Ω)  
**SMPTE intermodulation distortion** 0.01% (8 Ω)  
**Frequency response**  
 PHONO RIAA standard curve ±0.8 dB  
 CD, VCR 1, VCR 2, VCR 3, VDP, DAT, TAPE 7 Hz~70 kHz, ±3 dB

**Input sensitivity**  
 PHONO 0.4 mV (3 mV, IHF '66)  
 CD, VCR 1, VCR 2, VCR 3, VDP, DAT, TAPE 27 mV (200 mV, IHF '66)

**S/N (IHF, A)**  
 PHONO 70 dB (80 dB, IHF '66)  
 CD, VCR 1, VCR 2, VCR 3, VDP, DAT, TAPE 70 dB (90 dB, IHF '66)

**Phono maximum input voltage** 160 mV (IHF '66)  
**Input impedance**  
 PHONO 47 kΩ  
 CD, VCR 1, VCR 2, VCR 3, VDP, DAT, TAPE 22 kΩ

**Tone controls**  
 BASS 50 Hz, +10 dB~-10 dB  
 TREBLE 20 kHz, +10 dB~-10 dB  
**4 band parametric equalizer** +10 dB~-10 dB  
**Loudness control (volume at -30 dB)** 50 Hz, +9 dB  
**Low frequency damping factor** 30 (8 Ω)  
**Load impedance**  
 A or B 4~16 Ω  
 A and B 8~16 Ω

## ■ SURROUND AMPLIFIER SECTION

**Power output (Rear)** 1 kHz, 2 × 30 W (8 Ω)  
 (T.H.D. 0.8 %)

**Power output (Center)** 100 Hz~15 kHz, 60 W (8 Ω)  
 (T.H.D. 0.8 %)

## ■ DIGITAL SECTION (fs=44.1 kHz, EIAJ-D)

**Harmonic distortion (1 kHz)** 0.005%  
**Frequency response** +0.3 dB, -0.3 dB (2 Hz~20 kHz)

## ■ FM TUNER SECTION

**Frequency range** 87.50~108.00 MHz  
**Sensitivity** 11.2 dBf (2 μV, IHF '58)  
**50 dB quieting sensitivity**  
 MONO 20.2 dBf (5.6 μV, IHF '58)  
 STEREO 40.2 dBf (56 μV, IHF '58)

**Total harmonic distortion**  
 MONO 0.2%  
 STEREO 0.3%

**S/N**  
 MONO 75 dB  
 STEREO 70 dB

**Frequency response** 20 Hz~15 kHz, +1 dB, -2 dB  
**Alternate channel selectivity** 65 dB  
**Capture ratio** 1.0 dB  
**Image rejection at 98 MHz** 50 dB  
**IF rejection at 98 MHz** 90 dB  
**Spurious response rejection at 98 MHz** 80 dB  
**AM suppression** 50 dB  
**Stereo separation**  
 1 kHz 40 dB  
 10 kHz 30 dB  
**Carrier leak**  
 19 kHz -35 dB  
 38 kHz -50 dB  
**Antenna terminals** 75 Ω (unbalanced)

## ■ AM TUNER SECTION

**Frequency range** 522 kHz~1611 kHz (9-kHz steps)  
 530 kHz~1620 kHz (10-kHz steps)

**Sensitivity** 20 μV, 330 μV/m  
**Selectivity** 55 dB  
**Image rejection at 1000 kHz** 40 dB  
**IF rejection at 1000 kHz** 60 dB

## ■ VIDEO SECTION

**Output voltage at 1 V Input (unbalanced)** 1 ± 0.1 Vp-p  
**Maximum input voltage** 1.5 Vp-p  
**Input/output impedance** 75 Ω (unbalanced)

## ■ S VIDEO SECTION

**Rated input, Rated output/impedance**  
 Y 1 Vp-p, 1 Vp-p/75 Ω  
 C 0.286 Vp-p, 0.286 Vp-p/75 Ω

## ■ GENERAL

**Power consumption** 850 W  
**Power supply** AC 50 Hz/60 Hz, 110 V/127 V/220 V/240 V  
**Dimensions (W × H × D)** 430 × 158 × 429 mm  
 (16-15/16" × 6-7/32" × 16-7/8")  
**Weight** 15.2 kg (33.4 lb.)

### Notes:

- Total harmonic distortion is measured by the digital spectrum analyzer.
- Specifications are subject to change without notice. Weight and dimensions are approximate.

MASH is a trademark of NTT.



# Troubleshooting Guide

Before requesting service for this unit, check the chart below for a possible cause of the problem you are experiencing. Some simple checks or a minor adjustment on your part may eliminate the problem and restore proper operation.

If you are in doubt about some of the check points, or if the remedies indicated in the chart do not solve the problem, refer to the directory of authorized service centers (enclosed with this unit) to locate a convenient service center, or consult your Technics dealer for instructions.

(In U.S.A. consult MSC Authorized Servicenters for detailed instructions.)

Problem	Probable cause(s)	Suggested remedy
---------	-------------------	------------------

## While listening to FM broadcasts

<b>An unusual hissing noise is heard when listening to the broadcast in stereo, but not heard when listening monaurally.</b>	A slight noise may be heard because the method used for modulation of FM stereo broadcasts is different than that used for monaural broadcasts.	<ul style="list-style-type: none"> <li>• Try reducing the treble sound by using the equalizer controls.</li> <li>• Set the FM mode selector to the monaural position. (Note that the broadcast will then be heard as monaural sound.)</li> <li>• Try changing the location, height and/or direction of the antenna.</li> </ul>
<b>Noise is excessive in both stereo and monaural broadcasts.</b>	Poor location and/or direction of the antenna. Transmitting station is too far away.	<ul style="list-style-type: none"> <li>• If an indoor antenna is being used, change to an outdoor antenna.</li> <li>• Try using an antenna with more elements.</li> </ul>
<b>The FM stereo indicator or the quartz lock indicator flickers, without completely illuminating.</b>	Poor location and/or direction of the antenna. Transmitting station is too far away.	<ul style="list-style-type: none"> <li>• Try changing the location, height and/or direction of the antenna.</li> <li>• If an indoor antenna is being used, change to an outdoor antenna.</li> </ul>
<b>Excessive distortion in the sound of stereo broadcasts.</b>	Nearby building or mountain. [Multipath distortion is being caused by the mutual interference of broadcast signals received directly from the transmitting station (direct waves) and signals being reflected from nearby buildings or mountains (reflected waves).]	<ul style="list-style-type: none"> <li>• Try using an antenna with more elements.</li> </ul>

## While listening to AM broadcasts

<b>An unusual "beat" sound is heard.</b>	Unit is being used at the same time as the television set. Interference from adjacent broadcast signal.	<ul style="list-style-type: none"> <li>• Turn off the television set, or use this unit farther away from it.</li> <li>• Try reducing the treble sound by using the equalizer controls.</li> </ul>
<b>A low-pitched "hum" sound is heard when the broadcast is tuned.</b>	The AM loop antenna connection wires are too close to the power cord. The power supply frequency from the power cord is modulated and heard from the speakers.	<ul style="list-style-type: none"> <li>• Place the antenna connection wires and the power cord farther apart.</li> <li>• Install a special outdoor antenna.</li> </ul>
<b>A strange hissing noise is produced continuously or intermittently.</b>	Caused by the "discharge phenomenon" and the "oscillation phenomenon" of electric appliances (such as fluorescent lights, TV, small series-type motors, rectification equipment, etc.).	<ul style="list-style-type: none"> <li>• Try placing this unit farther away from such equipment.</li> <li>• Install noise-prevention equipment on this unit or on the electric appliance.</li> </ul>

## Problems noted at all times

<b>No sound is heard when the power is switched ON.</b>	The power cord plug is not completely inserted. Connections are incomplete or incorrect to the speaker systems, etc. The incorrect input selector has been pressed. The speaker selectors are incorrectly set to the "off" position.	<ul style="list-style-type: none"> <li>• Confirm that the power cord plug is connected completely.</li> <li>• Check to be sure that all connection wires are correctly connected.</li> <li>• Check to be sure that the correct selector is pressed.</li> <li>• Set to the "on" position.</li> </ul>
<b>Sound stops during a performance, or no sound is heard when the power is switched ON.</b>	The protection circuitry has functioned because the positive and negative speaker connection wires are "shorted" or speaker systems with an impedance less than the indicated rated impedance of this unit are used.	<ul style="list-style-type: none"> <li>• Switch off the power, and, after determining and correcting the cause, switch on the power once again.</li> <li>• Use a speaker system of the proper impedance rating.</li> </ul>
<b>Remote-control transmitter does not function.</b>	Batteries are incorrectly installed.	<ul style="list-style-type: none"> <li>• Insert the batteries so that the positive (+) and negative (-) polarities are correct.</li> </ul>

# Product service

Do not attempt to remove the cover(s) or repair the unit yourself.  
Refer servicing to qualified personnel only.

## Product information

---

For product service, product information or assistance in product operation, refer to the servicer directory.

# Index

- Audio input selector/frequency display  
(**INPUT SELECTOR/FREQUENCY**) ..... 14
- Audio power key ..... 16, 43
- Balance control (BALANCE)** ..... 11, 38
- Band indicators (**AM/FM**) ..... 14
- Band selectors ..... 13, 20
- Center frequency select/bass control  
(CENTER FREQ/BASS)** ..... 12, 27, 30
- Center mode indicators ..... 14, 32
- Center mode select button (**CENTER MODE**) ..... 12, 32
- Center speaker level adjustment button  
(**CENTER LEVEL**) ..... 12, 32
- Channel display ..... 14, 23
- Component display ..... 17
- Delay time adjustment button (DELAY TIME)** ..... 12, 35
- Delay time display (**DELAY TIME**) ..... 15
- Digital indicator ..... 14, 18
- Direct indicator ..... 17, 64
- Direct play key ..... 17, 64
- Display OFF/ON key ..... 16
- Display mode select button  
(**-DISPLAY MODE -DEMO**) ..... 11, 25
- Dolby Pro-Logic Surround ..... 32
- Dolby Pro-Logic Surround indicator ..... 15, 32
- Dolby 3 stereo indicator (**DOLBY 3 STEREO**) ..... 15, 37
- Dolby 3 stereo ON/OFF button (**3 STEREO**) ..... 12, 36, 37
- Dolby 3 stereo system ..... 36
- Dolby surround input balance control  
(**SURROUND INPUT BALANCE**) ..... 11, 34
- Equalization preset buttons (MANUAL PRESET)** ..... 11, 28
- Fine mode indicator (FINE)** ..... 15, 27
- Fine mode select button (**FINE**) ..... 12, 27
- Fixed preset button (**FIXED PRESET**) ..... 11, 29
- FM mode selector (**FM MODE**) ..... 13, 23
- FM stereo indicator (**STEREO**) ..... 14
- Frequency level/treble control (**LEVEL/TREBLE**) ..... 12, 30
- Function select keys ..... 16, 50
- Headphone jack (PHONES)** ..... 11, 18
- Input/function select keys** ..... 16
- Input selector buttons ..... 11, 18
- Loudness indicator (LOUDNESS)** ..... 14, 38
- Loudness switch (**LOUDNESS**) ..... 11, 38
- Manual/fixed preset indicators (1 2 3 FLAT)** ..... 15, 29
- Memory button (**MEMORY**) ..... 13, 21
- Memory indicator (**MEMORY**) ..... 14, 21
- Memory scan button (**MEMORY SCAN**) ..... 13, 23
- Memory scan indicator (**M. SCAN**) ..... 14
- Multi-function keys ..... 17, 65
- Muting indicator (**MUTING**) ..... 14, 43
- Muting key ..... 16, 43
- OK** / **ERROR** indicators ..... 17, 69
- Operation keys ..... 16, 68
- Operation mode indicators ..... 17
- Operation mode select keys ..... 16, 69
- Optional keys ..... 16, 68
- Parametric EQ band select buttons** ..... 11, 26
- Parametric EQ mode indicator (**P. EQ MODE**) ..... 15, 26
- Parametric EQ system ..... 24
- Parametric EQ system center frequency display ..... 15, 27
- Parametric EQ system memory button (**MEMORY**) ..... 11, 28
- Parametric EQ system memory indicator (**M**) ..... 15, 28
- Parametric EQ system off indicator (**OFF**) ..... 15, 26
- Parametric EQ system ON/OFF button (**P. EQ SYS**) ..... 12, 26
- Parametric EQ system operation select indicators  
(**MANUAL/FIXED**) ..... 15
- Parametric EQ/tone mode select button  
(**P. EQ/TONE**) ..... 12, 26
- Power "⏻ STANDBY/ON" switch  
(**POWER ⏻ STANDBY/ON**) ..... 13, 18
- Preset-tuning buttons (1-0)  
(**30 CHANNEL RANDOM PRESET TUNING**) ..... 13, 21
- Quartz-lock indicator (QUARTZ LOCK)** ..... 14
- Rear/center level indicator** ..... 14
- Rear speaker volume keys ..... 17, 55
- Remote-control signal receptor (**REMOTE SENSOR**) ..... 13, 42
- Rear speaker level adjustment button  
(**REAR LEVEL**) ..... 12, 32, 35
- Sampling frequency indicators  
(SAMPLING FREQUENCY)** ..... 15
- Slope changeover button (**SLOPE(Q)**) ..... 12, 27
- Speaker selectors (**SPEAKERS**) ..... 11, 18
- Spectrum analysis/parametric EQ level display  
(**SPECTRUM ANALYZER/PARAMETRIC EQ**) ..... 14
- "STANDBY" indicator (**STANDBY**) ..... 13, 43
- Surround mode display (**SURROUND**) ..... 15, 32
- Surround mode select button (**SURROUND MODE**) ..... 12, 32
- Surround ON/OFF button (**SURROUND**) ..... 12, 32
- Surround ON/OFF key ..... 17, 55
- S-video terminals ..... 5, 19
- Tape indicator (TAPE)** ..... 14, 39
- Tape monitor switch (**TAPE MONITOR**) ..... 11, 18
- Test signal indicator (**■ TEST**) ..... 14
- Test signal transmission button (**TEST**) ..... 12, 32
- Tone mode indicator (**TONE MODE**) ..... 15, 30
- Tuning control (**TUNING**) ..... 13, 20
- Tuning mode selector/indicator (**TUNING MODE**) ..... 13, 20
- TV input indicator ..... 17
- VCR display (VCR)** ..... 14, 40
- "VCR 3" terminals (**VCR 3**) ..... 11, 41
- VDP indicator (**VDP**) ..... 15
- Volume control (**VOLUME**) ..... 11, 18
- Volume keys ..... 16, 43

---

**Matsushita Electric Industrial Co., Ltd.**  
Central P.O. Box 288, Osaka 530-91, Japan

